

## Test Report

### (EN 50155 & EN 50121-3-2)

**Report No.:** CEBDBO-WTW-P21100593-1

**Test Model:** SPC-6000

**Series Model:** SPC-6000 Series, SPC-6XXXXXXXXXXXXXXXXXXXXXXXXXXXXX  
("X" can be 0-9, A-Z or blank for marketing purposes)

**Received Date:** 2021/10/19

**Test Date:** 2021/10/25 ~ 2021/12/15

**Issued Date:** 2021/12/21

**Applicant:** Vecow Co., Ltd.

**Address:** 3F., No.10, Jiankang Rd., Zhonghe Dist., New Taipei City 23586, Taiwan

**Issued By:** Bureau Veritas Consumer Products Services (H.K.) Ltd., Taoyuan Branch  
Lin Kou Laboratories

**Lab Address:** No. 47-2, 14th Ling, Chia Pau Vil., Lin Kou Dist., New Taipei City, Taiwan



This report is for your exclusive use. Any copying or replication of this report to or for any other person or entity, or use of our name or trademark, is permitted only with our prior written permission. This report sets forth our findings solely with respect to the test samples identified herein. The results set forth in this report are not indicative or representative of the quality or characteristics of the lot from which a test sample was taken or any similar or identical product unless specifically and expressly noted. Our report includes all of the tests requested by you and the results thereof based upon the information that you provided to us. You have 60 days from date of issuance of this report to notify us of any material error or omission caused by our negligence, provided, however, that such notice shall be in writing and shall specifically address the issue you wish to raise. A failure to raise such issue within the prescribed time shall constitute your unqualified acceptance of the completeness of this report, the tests conducted and the correctness of the report contents. Unless specifically mentioned, the uncertainty of measurement has been explicitly taken into account to declare the compliance or non-compliance to the specification.

## Table of Contents

<b>Release Control Record</b> .....	<b>4</b>
<b>1 Certificate of Conformity</b> .....	<b>5</b>
<b>2 Summary of Test Results</b> .....	<b>6</b>
2.1 Performance Criteria .....	9
2.2 Measurement Uncertainty .....	9
2.3 Modification Record.....	9
<b>3 General Information</b> .....	<b>10</b>
3.1 Description of EUT .....	10
3.2 Features of EUT .....	10
3.3 Operating Modes of EUT and Determination of Worst Case Operating Mode .....	10
3.4 Test Program Used and Operation Descriptions.....	11
3.5 Primary Clock Frequencies of Internal Source .....	11
<b>4 Configuration and Connections with EUT</b> .....	<b>12</b>
4.1 Connection Diagram of EUT and Peripheral Devices.....	12
4.2 Configuration of Peripheral Devices and Cable Connections .....	14
<b>5 Conducted Disturbance at Auxiliary a.c. or d.c. Power Ports</b> .....	<b>16</b>
5.1 Limits .....	16
5.2 Test Instruments .....	16
5.3 Test Arrangement .....	17
5.4 Test Results .....	18
<b>6 Radiated Disturbance up to 1 GHz</b> .....	<b>20</b>
6.1 Limits .....	20
6.2 Test Instruments .....	20
6.3 Test Arrangement .....	21
6.4 Test Results .....	22
<b>7 Radiated Disturbance above 1 GHz</b> .....	<b>24</b>
7.1 Limits .....	24
7.2 Test Instruments .....	25
7.3 Test Arrangement .....	26
7.4 Test Results .....	27
<b>8 Harmonics Current Measurement</b> .....	<b>29</b>
8.1 Limits .....	29
8.2 Classification of Equipment.....	29
8.3 Test Instruments .....	29
8.4 Test Arrangement .....	30
8.5 Test Results .....	30
<b>9 Voltage Fluctuations and Flicker Measurement</b> .....	<b>31</b>
9.1 Limits .....	31
9.2 Test Instruments .....	31
9.3 Test Arrangement .....	31
9.4 Test Results .....	32
<b>10 Electrostatic Discharge Immunity Test (ESD)</b> .....	<b>33</b>
10.1 Test Specification.....	33
10.2 Test Instruments .....	33
10.3 Test Arrangement .....	33
10.4 Test Results .....	35

<b>11</b>	<b>Radio-frequency Electromagnetic Field Immunity Test (RS)</b> .....	<b>38</b>
11.1	Test Specification.....	38
11.2	Test Instruments .....	39
11.3	Test Arrangement .....	40
11.4	Test Results .....	41
<b>12</b>	<b>Electrical Fast Transient/Burst Immunity Test (EFT)</b> .....	<b>42</b>
12.1	Test Specification.....	42
12.2	Test Instruments .....	42
12.3	Test Arrangement .....	43
12.4	Test Results .....	44
<b>13</b>	<b>Surge Immunity Test</b> .....	<b>45</b>
13.1	Test Specification.....	45
13.2	Test Instruments .....	45
13.3	Test Arrangement .....	46
13.4	Test Results .....	46
<b>14</b>	<b>Immunity to Conducted Disturbances Induced by RF Fields (CS)</b> .....	<b>47</b>
14.1	Test Specification.....	47
14.2	Test Instruments .....	47
14.3	Test Arrangement .....	49
14.4	Test Results .....	50
<b>15</b>	<b>Pictures of Test Arrangements</b> .....	<b>51</b>
15.1	Conducted Disturbance at Auxiliary a.c. or d.c. power ports .....	51
15.2	Radiated Disturbance up to 1 GHz .....	52
15.3	Radiated Disturbance above 1 GHz.....	53
15.4	Harmonics Current, Voltage Fluctuations and Flicker Measurement.....	54
15.5	Electrostatic Discharge Immunity Test (ESD) .....	54
15.6	Radio-frequency Electromagnetic Field Immunity Test (RS) .....	55
15.7	Fast Transients (EFT).....	56
15.8	Surge .....	58
15.9	Radio-frequency common mode (CS).....	59
<b>Appendix – Information of the Testing Laboratories</b> .....		<b>61</b>

### Release Control Record

Issue No.	Description	Date Issued
CEBDBO-WTW-P21100593-1	Original release.	2021/12/21

## 1 Certificate of Conformity

**Product:** Ultra-Compact Fanless Embedded System  
**Brand:** Vecow  
**Test Model:** SPC-6000  
**Series Model:** SPC-6000 Series, SPC-6XXXXXXXXXXXXXXXXXXXXXXXXXXXXX  
("X" can be 0-9, A-Z or blank for marketing purposes)  
**Sample Status:** Engineering sample  
**Applicant:** Vecow Co., Ltd.  
**Test Date:** 2021/10/25 ~ 2021/12/15  
**Standards:** **EN 50155:2017, Clause 13.4.8**  
**EN 61000-3-2:2014**  
**EN 61000-3-3:2013**  
**EN 50121-1:2017**  
**EN 50121-3-2:2016**  
EN 61000-4-2:2009  
EN 61000-4-3:2006 +A1:2008 +A2:2010  
EN 61000-4-4:2012  
EN 61000-4-5:2014 +A1:2017  
EN 61000-4-6:2014 +AC:2015

The above equipment has been tested by **Bureau Veritas Consumer Products Services (H.K.) Ltd., Taoyuan Branch**, and found compliance with the requirement of the above standards. The test record, data evaluation & Equipment Under Test (EUT) configurations represented herein are true and accurate accounts of the measurements of the sample's EMC characteristics under the conditions specified in this report.

**Prepared by :** Albee Chu , **Date:** 2021/12/21  
Albee Chu / Senior Specialist

**Approved by :** Jim Hsiang , **Date:** 2021/12/21  
Jim Hsiang / Associate Technical Manager

## 2 Summary of Test Results

EN 50121-3-2:2016, Emission requirements, EN 50155:2017, Clause 13.4.8			
Port	Test Item / specifications	Result/Remarks	Verdict
Auxiliary a.c. or d.c. power ports - Auxiliary supply sinusoidal a.c. or d.c.	Conducted disturbance 150 kHz- 500 kHz: 99 dB $\mu$ V quasi-peak 500 kHz- 30 MHz: 93 dB $\mu$ V quasi-peak	Minimum passing margin is -44.45 dB at 0.15001 MHz	Pass
Auxiliary a.c. or d.c. power ports – AC power outlet port for public use	Conducted disturbance 50 Hz- 2 kHz: THD <8% (THD: total harmonic distortion)	Test not applicable because the port does not exist.	N/A
Battery referenced ports - Battery power supply	Conducted disturbance 150 kHz- 500 kHz: 99 dB $\mu$ V quasi-peak 500 kHz- 30 MHz: 93 dB $\mu$ V quasi-peak	Test not applicable because the port does not exist.	N/A
Enclosure	Radiated disturbance 30 MHz- 230 MHz: 40 dB $\mu$ V/m quasi-peak 230 MHz -1 GHz: 47 dB $\mu$ V/m quasi-peak	Minimum passing margin is -0.37 dB at 462.00 MHz	Pass
Enclosure	Radiated disturbance 1 GHz- 3 GHz: 76 dB $\mu$ V/m peak 56 dB $\mu$ V/m average 3 GHz - 6 GHz: 80 dB $\mu$ V/m peak 60 dB $\mu$ V/m average	Minimum passing margin is -5.69 dB at 1694.03 MHz	Pass

Emission requirements			
Standard	Test Item / specifications	Result/Remarks	Verdict
EN 61000-3-2:2014	Harmonic current emissions	The power consumption of EUT is less than 75W and no limits apply	Pass
EN 61000-3-3:2013	Voltage fluctuations and flicker	$P_{st} \leq 1.0$ $d_{max} \leq 4\%$ $P_{lt} \leq 0.65$ $d_c \leq 3.3\%$ $T_{max} \leq 500ms$	Pass

EN 50121-3-2:2016, Immunity requirements, EN 50155:2017, Clause 13.4.8					
Table Clause	Basic standard	Port	Test Item / specifications	Result/Remarks	Verdict
3.1	EN 61000-4-6:2014 +AC:2015	Battery referenced ports (except at the output of energy sources), Auxiliary a.c. power input ports (rated voltage $\leq 400$ Vrms)	Radio-frequency common mode (CS) 80% AM (1kHz) 0.15-80 MHz, 10V Performance Criterion A	Performance Criterion A	Pass
3.2	EN 61000-4-4:2012	Battery referenced ports (except at the output of energy sources), Auxiliary a.c. power input ports (rated voltage $\leq 400$ Vrms)	Fast Transients (EFT) 5/50 ( $t_r/t_w$ ) ns, 5kHz $\pm 2$ kV Performance Criterion A	Performance Criterion A	Pass
3.3	EN 61000-4-5:2014 +A1:2017	Battery referenced ports (except at the output of energy sources), Auxiliary a.c. power input ports (rated voltage $\leq 400$ Vrms)	Surges 1.2/50 (8/20) ( $T_f/T_d$ ) $\mu$ s Line to ground: $\pm 2$ kV 42 $\Omega$ , 0.5 $\mu$ F Line to line: $\pm 1$ kV 42 $\Omega$ , 0.5 $\mu$ F Performance Criterion B	Performance Criterion A	Pass
4.1	EN 61000-4-6:2014 +AC:2015	Signal & communication, process measurement & control ports	Radio-frequency common mode (CS) 80% AM (1kHz) 0.15-80 MHz, 10V Performance Criterion A	Judge by client	-
4.2	EN 61000-4-4:2012	Signal & communication, process measurement & control ports	Fast Transients (EFT) 5/50 ( $t_r/t_w$ ) ns, 5kHz $\pm 2$ kV, Capacitive clamp Performance Criterion A	Performance Criterion A	Pass
5.1	EN 61000-4-3:2006 +A1:2008 +A2:2010	Enclosure ports	Radio-frequency electromagnetic field amplitude modulated (RS) <sup>1</sup> , 80% AM (1kHz) 80-800 MHz, 20V/m Performance Criterion A	Performance Criterion A	Pass
5.2	EN 61000-4-3:2006 +A1:2008 +A2:2010	Enclosure ports	Radio-frequency electromagnetic field from digital mobile telephones (RS) <sup>2</sup> , 80% AM (1kHz) 800-1000 MHz, 20V/m 1400-2000 MHz, 10V/m 2000-2700 MHz, 5V/m 5100-6000 MHz, 3V/m Performance Criterion A	Performance Criterion A	Pass

EN 50121-3-2:2016, Immunity requirements,  
EN 50155:2017, Clause 13.4.8

Table Clause	Basic standard	Port	Test Item / specifications	Result/Remarks	Verdict
5.3	EN 61000-4-2:2009	Enclosure ports	Electrostatic Discharges (ESD) ±6kV Contact discharge ±8kV Air discharge Performance Criterion B	Performance Criterion B	Pass

Note 1: This limit applies to equipment mounted in the passenger compartments, drivers cab or external to the rolling stock (roof, underframe). For equipment mounted in all other areas a severity level of 10 V/m may be used.

Note 2: For large apparatus (e.g. traction drives, auxiliary converters) it is often not practical to perform the immunity test to radiated electromagnetic fields on the complete unit. In such cases the manufacturer should test susceptible sub-systems (e.g. control electronics). The test report should justify the selection or not of sub-systems and any assumptions made (e.g. reduction of field due to case shielding).

Note:

1. There is no deviation to the applied test methods and requirements covered by the scope of this report.
2. The above EN basic standards are applied with latest version if customer has no special requirement.
3. Determining compliance based on the results of the compliance measurement, not taking into account measurement instrumentation uncertainty.
4. N/A: Not Applicable



## 2.1 Performance Criteria

### General Performance Criteria

The general performance criteria apply for those ports for which no specific performance criteria are defined (e.g. auxiliary ports) in the report.

**Performance criterion A:** The apparatus shall continue to operate as intended during and after the test. No degradation of performance or loss of function is allowed below a performance level specified by the manufacturer, when the apparatus is used as intended. The performance level may be replaced by a permissible loss of performance. If the minimum performance level or the permissible performance loss is not specified by the manufacturer, either of these may be derived from the product description and documentation, and from what the user may reasonably expect from the apparatus if used as intended..

**Performance criterion B:** The apparatus shall continue to operate as intended after the test. No degradation of performance or loss of function is allowed below a performance level specified by the manufacturer, when the apparatus is used as intended. The performance level may be replaced by a permissible loss of performance. During the test, degradation of performance is however allowed. No change of actual operating state or stored data is allowed. If the minimum performance level or the permissible performance loss is not specified by the manufacturer, either of these may be derived from the product description and documentation, and from what the user may reasonably expect from the apparatus if used as intended.

**Performance criterion C:** Temporary loss of function is allowed, provided the function is self-recoverable or can be restored by the operation of the controls.

## 2.2 Measurement Uncertainty

Where relevant, the following measurement uncertainty levels have been estimated for tests performed on the EUT as specified in CISPR 16-4-2:

Measurement	Expanded Uncertainty (k=2) ( $\pm$ )	Maximum allowable uncertainty ( $\pm$ )
Conducted disturbance at mains port using AMN, 150kHz ~ 30MHz	2.94 dB	3.4 dB ( $U_{\text{CISPR}}$ )
Radiated disturbance, 30MHz ~ 1GHz	4.30 dB	6.3 dB ( $U_{\text{CISPR}}$ )
Radiated disturbance, 1GHz ~ 6GHz	4.96 dB	5.2 dB ( $U_{\text{CISPR}}$ )

The other instruments specified are routine verified to remain within the calibrated levels, no measurement uncertainty is required to be calculated.

## 2.3 Modification Record

There were no modifications required for compliance.

### 3 General Information

#### 3.1 Description of EUT

Product	Ultra-Compact Fanless Embedded System
Brand	Vecow
Test Model	SPC-6000
Series Model	SPC-6000 Series, SPC-6XXXXXXXXXXXXXXXXXXXXXXXXXXXXX ("X" can be 0-9, A-Z or blank for marketing purposes)
Model Difference	For marketing purpose
Sample Status	Engineering sample
Operating Software	WIN10, BURINTEST V9.2
Power Supply Rating	DC from Adapter
Accessory Device	N/A
Data Cable Supplied	N/A

Note:

The EUT uses following adapter.

Brand	LITEON
Model	HA-1600-12
Input Power	100-240Vac, 1.7A, 50-60Hz
Output Power	12Vdc, 5.0A, 60W
Power Line	Non-shielded AC cable (1.8m, 3 Pin) DC cable (1.2m) with one ferrite core.

#### 3.2 Features of EUT

1. The tests reported herein were performed according to the method specified by Vecow Co., Ltd., for detailed feature description, please refer to the manufacturer's specifications or user's manual.
2. The EUT was configured with the following key components:

Components	Brand	Model	Specification
CPU	Intel	Atom <sup>®</sup> X6425RE	1.9GHz
RAM	innodisk	-	16GB, DDR4 2666 W/T SODIMM
M.2 SSD	MEMXPRO	PT31	256GB

#### 3.3 Operating Modes of EUT and Determination of Worst Case Operating Mode

1. The EUT is designed with AC power of rating 100-240Vac, 50-60Hz.  
For radiated emission evaluation, 230Vac/50Hz (for EN 50155), 120Vac/60Hz (for FCC Part 15) had been covered during the pre-test. The worst data was found at **230Vac/50Hz** and recorded in the applied test report.
2. Test modes are presented in the report as below.

Mode	Test Condition	Input Power
1	Full System	230Vac/ 50Hz

### 3.4 Test Program Used and Operation Descriptions

#### Emission tests (Harmonics & Flicker excluded):

- a. Turned on the power of all equipment.
- b. EUT ran a test program to enable all functions.
- c. EUT read and wrote messages from/to SSD and ext. HDDs.
- d. EUT sent and received messages to/from Notebook PC/ Desktop PC (kept in a remote area) via two UTP LAN cables (10m each).
- e. EUT sent "H" messages to LCD Monitors. Then they displayed "H" messages on their screens.
- f. EUT sent "1kHz audio" signal to earphone.
- g. Steps c-f were repeated.

#### Harmonics, Flicker, Immunity tests:

- a. Turned on the power of all equipment.
- b. EUT ran a test program to enable all functions.
- c. EUT read and wrote messages from/to SSD and USB flash drives.
- d. EUT sent and received messages to/from Desktop PCs (kept in a remote area) via two STP LAN cables (10m each).
- e. EUT sent "color bars with moving element" messages to LCD Monitors. Then they displayed "color bars with moving element" messages on their screens.
- f. EUT sent audio signal to speaker.
- g. Steps c-f were repeated.

### 3.5 Primary Clock Frequencies of Internal Source

The highest frequency generated or used within the EUT or on which the EUT operates or tunes is 1.9GHz, provided by Vecow Co., Ltd., for detailed internal source, please refer to the manufacturer's specifications.

#### 4 Configuration and Connections with EUT

##### 4.1 Connection Diagram of EUT and Peripheral Devices

Emission tests (Harmonics & Flicker excluded):

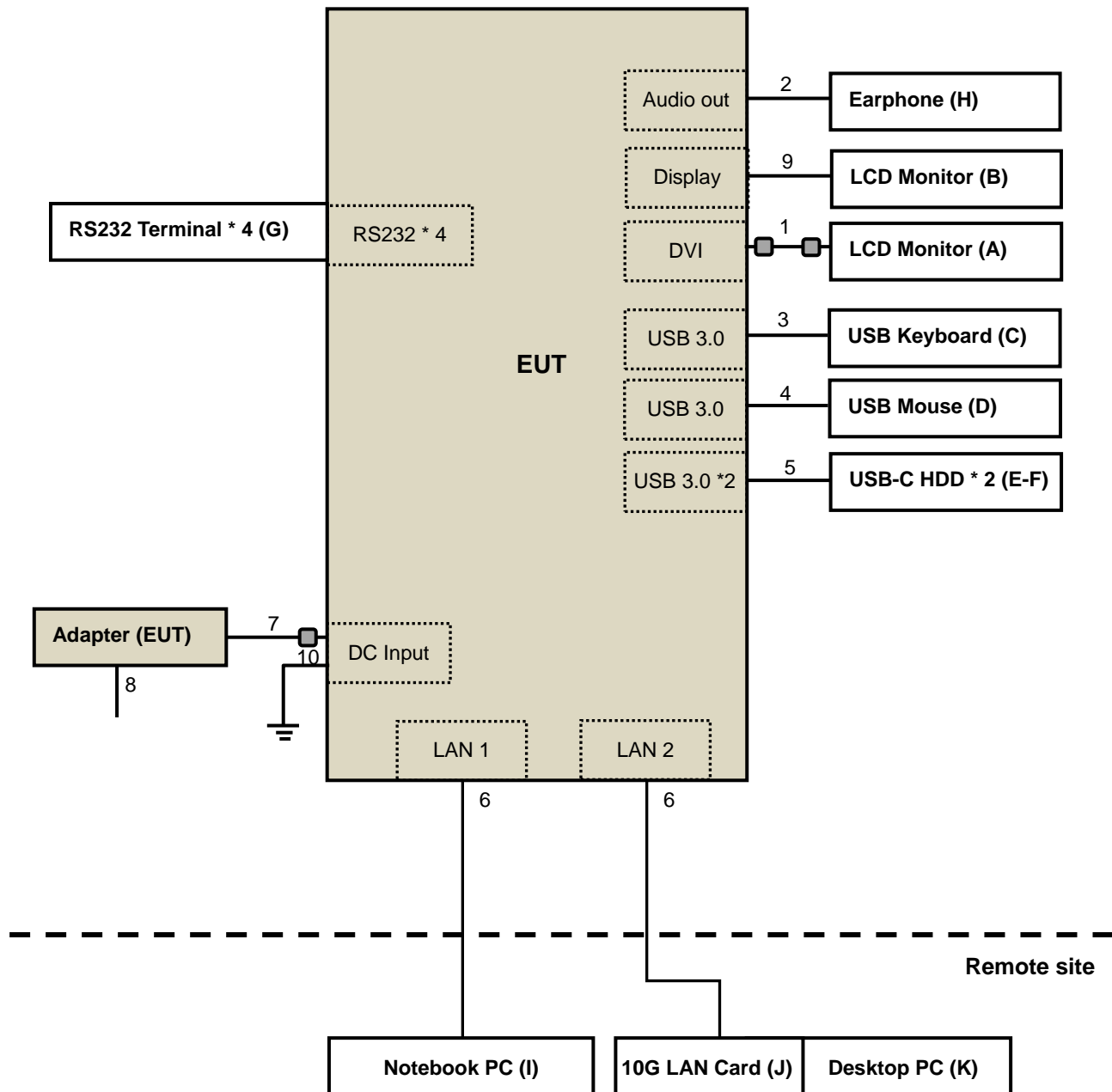

Harmonics & Flicker & Immunity tests:

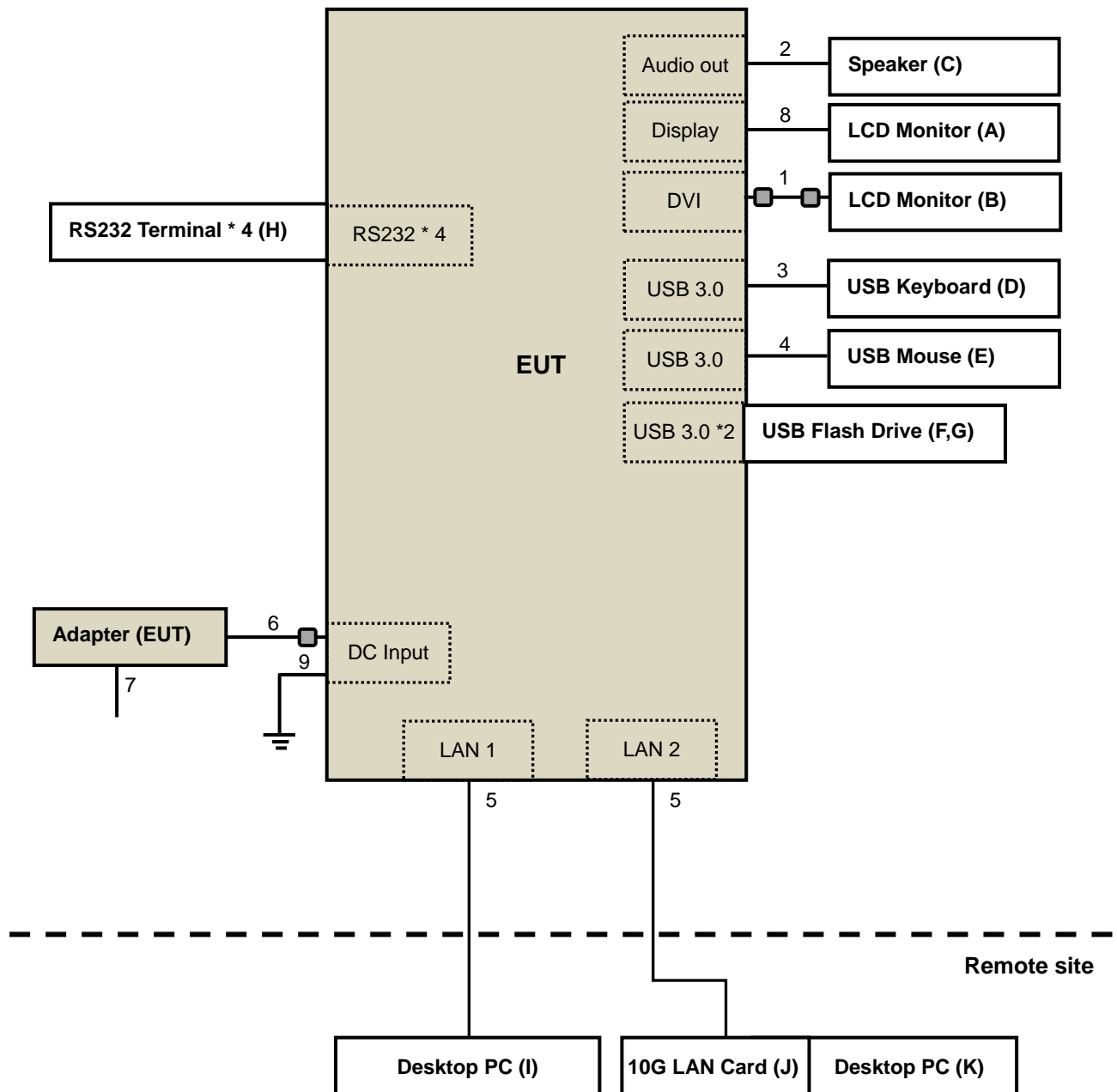

## 4.2 Configuration of Peripheral Devices and Cable Connections

Emission tests (Harmonics & Flicker excluded):

ID	Product	Brand	Model No.	Serial No.	FCC ID	Remarks
A.	LCD Monitor	ASUS	MG28UQ	J1LMTF114792	N/A	Provided by Lab
B.	LCD Monitor	DELL	U2410	CN082WXD728720C C0KCL	FCC DoC Approved	Provided by Lab
C.	USB Keyboard	Dell	KB216t	CN-0W33XP-LO300- 7CL-1907	N/A	Provided by Lab
D.	USB Mouse	DELL	MOCZUL	CN-049TWY-PRC00- 77B-007R	N/A	Provided by Lab
E.	USB-C Hard Disk	G-DRIVE	0G04878	620VKK7W	FCC DoC Approved	Provided by Lab
F.	USB-C Hard Disk	G-DRIVE	0G04878	620VPJ7W	FCC DoC Approved	Provided by Lab
G.	RS232 Terminal* 4	NA	NA	NA	NA	Supplied by client
H.	EARPHONE	PHILIPS	SBC HL145	N/A	N/A	Provided by Lab
I.	Notebook PC	SONY	SVS151A12P	2.75548E+14	N/A	Provided by Lab
J.	10G LAN CARD	ASUS	XG-C100C	K5QSRT001881	FCC DoC Approved	Provided by Lab
K.	Desktop PC	DELL	3010 SF	1JWQS02	N/A	Provided by Lab

ID	Cable Descriptions	Qty.	Length (m)	Shielding (Yes/No)	Cores (Qty.)	Remarks
1.	DVI cable	1	1.8	Y	2	Provided by Lab
2.	Audio cable	1	1.2	N	0	Provided by Lab
3.	USB cable	1	1.8	Y	0	Provided by Lab
4.	USB cable	1	1.8	Y	0	Provided by Lab
5.	USB-A to USB-C cable	2	1.0	Y	0	Provided by Lab
6.	LAN cable	2	10	Y	0	Provided by Lab (RJ45, Cat.5e)
7.	DC power cable	1	1.2	N	1	Supplied by client
8.	AC power cable	1	1.8	N	0	Provided by Lab
9.	Display cable	1	1.8	Y	0	Provided by Lab
10.	GND cable	1	1.5	N	0	Provided by Lab

**Harmonics, Flicker, Immunity tests:**

ID	Product	Brand	Model No.	Serial No.	FCC ID	Remarks
A.	LCD MONITOR	DELL	P2415Qb	CN-OGTTPW-74261-6 62-OAAL	FCC DoC Approved	Provided by Lab
B.	LCD MONITOR	DELL	U2412M	CN-07N2FG-TV100-7B G-093L	FCC DoC Approved	Provided by Lab
C.	Speaker	NA	NA	NA	NA	Provided by Lab
D.	USB Keyboard	DELL	KB4021	CN-05V23T-71581-1AK -00MT-A01	FCC DoC Approved	Provided by Lab
E.	USB Mouse	HP	MODGUO	NA	NA	Provided by Lab
F.	USB Flash Drive	HP	X750W	NA	NA	Provided by Lab
G.	USB Flash Drive	HP	X750W	NA	NA	Provided by Lab
H.	RS232 Terminal* 4	NA	NA	NA	NA	Provided by Lab
I.	Desktop PC	DELL	3010 SF	1JWQS02	NA	Provided by Lab
J.	10G LAN CARD	ASUS	XG-C100C	NA	NA	Provided by Lab
K.	Desktop PC	DELL	OptiPlex 390SF Base	F3PVWBX	NA	Provided by Lab

ID	Cable Descriptions	Qty.	Length (m)	Shielding (Yes/No)	Cores (Qty.)	Remarks
1.	DVI cable	1	1.8	Y	2	Provided by Lab
2.	Audio cable	1	1.2	N	0	Provided by Lab
3.	USB cable	1	1.8	Y	0	Provided by Lab
4.	USB cable	1	1.8	Y	0	Provided by Lab
5.	LAN cable	2	10	Y	0	Provided by Lab (RJ45, Cat.5e)
6.	DC power cable	1	1.2	N	1	Supplied by client
7.	AC power cable	1	1.8	N	0	Provided by Lab
8.	Display cable	1	1.8	Y	0	Provided by Lab
9.	GND cable	1	1.0	N	0	Provided by Lab

## 5 Conducted Disturbance at Auxiliary a.c. or d.c. Power Ports

### 5.1 Limits

Frequency (MHz)	Quasi-peak, (dBuV)
0.15 - 0.5	99
0.5 - 30	93

- Notes: 1. The lower limit shall apply at the transition frequencies.  
 2. The limit decreases linearly with the logarithm of the frequency in the range of 0.15 to 0.50 MHz.

### 5.2 Test Instruments

Description & Manufacturer	Model No.	Serial No.	Calibrated Date	Calibrated Until
Test Receiver R&S	ESR3	102413	2021/2/8	2022/2/7
LISN R&S	ESH2-Z5	100104	2020/12/18	2021/12/17
LISN SCHWARZBECK	NNLK8129	8129229	2021/5/20	2022/5/19
DC LISN SCHWARZBECK	NNLK 8121	8121-808	2021/4/18	2022/4/17
LISN SCHWARZBECK	NNLK 8121	8121-731	2021/4/28	2022/4/27
LISN R & S	ESH3-Z5	847265/023	2020/11/11	2021/11/10
LISN R&S	ENV216	101196	2021/4/26	2022/4/25
LISN R&S	ESH3-Z6	844950/018	2021/7/25	2022/7/24
DC LISN R&S	ESH3-Z6	100219	2021/7/25	2022/7/24
RF Coaxial Cable Commate	5D-FB	Cable-CO9-01	2021/8/13	2022/8/12
Attenuator STI	STI02-2200-10	NO.2	2021/8/13	2022/8/12
50 ohms Terminator LYNICS	0900510	E1-01-299	2021/1/27	2022/1/26
Isolation Transformer Erika Fiedler	D-65396	017	2021/9/9	2022/9/8
Software BVADT	Cond_V7.3.7.4	NA	NA	NA

- Note: 1. The calibration interval of the above test instruments is 12 months and the calibrations are traceable to NML/ROC and NIST/USA.  
 2. The test was performed in Linkou Conduction 09.  
 3. The VCCI Site Registration No. C-11312.  
 4. Tested Date: 2021/10/25



### 5.3 Test Arrangement

- The EUT was placed 0.4 meters from the conducting wall of the shielded room with EUT being connected to the power mains through a line impedance stabilization network (LISN). Other support units were connected to the power mains through another LISN. The two LISNs provide 50 Ohm/ 50uH of coupling impedance for the measuring instrument.
- Both lines of the power mains connected to the EUT were checked for maximum conducted interference.
- The test results of conducted emissions at mains ports are recorded of six worst margins for quasi-peak (mandatory) [and average (if necessary)] values against the limits at frequencies of interest unless the margin is 20 dB or greater.

Note: The resolution bandwidth and video bandwidth of test receiver is 9kHz for quasi-peak detection (QP) and average detection (AV) at frequency 0.15MHz-30MHz.

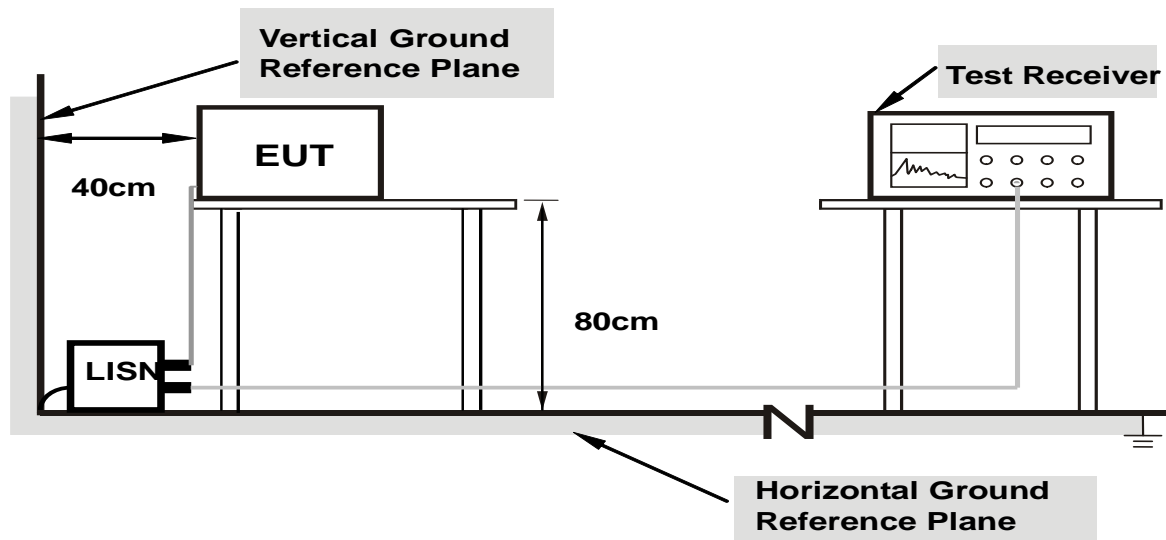

**Note: Support units were connected to second LISN.**

For the actual test configuration, please refer to the related item – Photographs of the Test Configuration.

## 5.4 Test Results

### Mode 1

<b>Frequency Range</b>	150kHz ~ 30MHz	<b>Detector Function &amp; Resolution Bandwidth</b>	Quasi-Peak (QP) / Average (AV), 9kHz
<b>Input Power</b>	230Vac, 50Hz	<b>Environmental Conditions</b>	26 °C, 78% RH
<b>Tested by</b>	Ed. Lin		

Phase Of Power : Line (L)						
No	Frequency (MHz)	Correction Factor (dB)	Reading Value (dBuV)	Emission Level (dBuV)	Limit (dBuV)	Margin (dB)
			Q.P.	Q.P.	Q.P.	Q.P.
1	0.15001	10.07	43.61	53.68	99.00	-45.32
2	0.16932	10.07	40.49	50.56	99.00	-48.44
3	0.22203	10.07	35.55	45.62	99.00	-53.38
4	0.65761	10.11	25.53	35.64	93.00	-57.36
5	4.53607	10.36	9.74	20.10	93.00	-72.90
6	17.10400	10.94	26.95	37.89	93.00	-55.11

#### Remarks:

1. Q.P. and AV. are abbreviations of quasi-peak and average individually.
2. The emission levels of other frequencies were very low against the limit.
3. Margin value = Emission level – Limit value
4. Correction factor = Insertion loss + Cable loss
5. Emission Level = Correction Factor + Reading Value

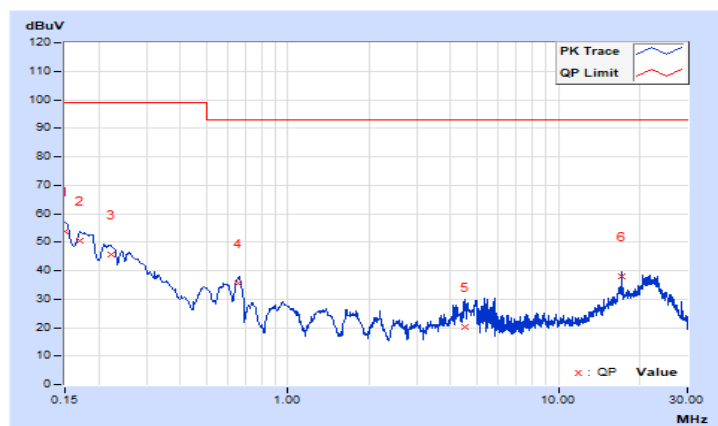

<b>Frequency Range</b>	150kHz ~ 30MHz	<b>Detector Function &amp; Resolution Bandwidth</b>	Quasi-Peak (QP) / Average (AV), 9kHz
<b>Input Power</b>	230Vac, 50Hz	<b>Environmental Conditions</b>	26 °C, 78% RH
<b>Tested by</b>	Ed. Lin		

Phase Of Power : Neutral (N)						
No	Frequency (MHz)	Correction Factor (dB)	Reading Value (dBuV)	Emission Level (dBuV)	Limit (dBuV)	Margin (dB)
			Q.P.	Q.P.	Q.P.	Q.P.
1	0.15001	10.08	44.47	54.55	99.00	-44.45
2	0.16977	10.08	40.57	50.65	99.00	-48.35
3	0.21294	10.08	36.49	46.57	99.00	-52.43
4	0.64388	10.12	24.58	34.70	93.00	-58.30
5	4.96022	10.38	15.51	25.89	93.00	-67.11
6	17.10409	10.78	27.37	38.15	93.00	-54.85

**Remarks:**

1. Q.P. and AV. are abbreviations of quasi-peak and average individually.
2. The emission levels of other frequencies were very low against the limit.
3. Margin value = Emission level – Limit value
4. Correction factor = Insertion loss + Cable loss
5. Emission Level = Correction Factor + Reading Value

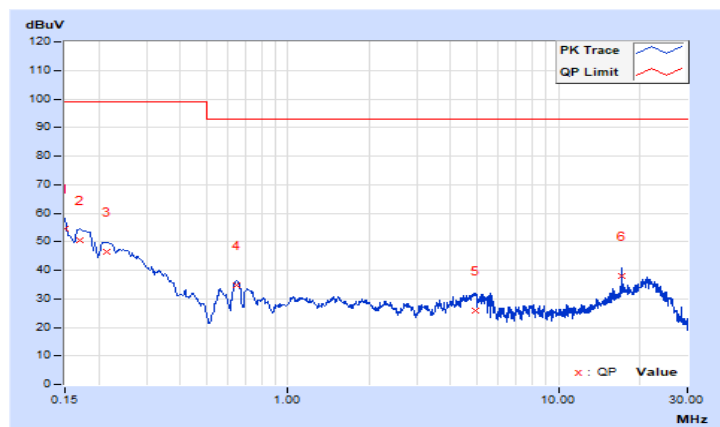

## 6 Radiated Disturbance up to 1 GHz

### 6.1 Limits

Frequency (MHz)	dBuV/m (at 10m) / quasi-peak
30 - 230	40
230 - 1000	47

- Notes:
1. The lower limit shall apply at the transition frequencies.
  2. Emission level (dBuV/m) = 20 log Emission level (uV/m).
  3. All emanations from a class A/B digital device or system, including any network of conductors and apparatus connected thereto, shall not exceed the level of field strengths specified above.

### 6.2 Test Instruments

Description & Manufacturer	Model No.	Serial No.	Calibrated Date	Calibrated Until
TEST RECEIVER R&S	ESCS 30	100292	2021/9/1	2022/8/31
TEST RECEIVER R&S	ESCS 30	100276	2021/4/15	2022/4/14
Bi-log Broadband Antenna Schwarzbeck	VULB9168	9168-303	2021/10/29	2022/10/28
Pre_Amplifier HP	8447D	2944A08119	2021/2/18	2022/2/17
RF Coaxial Cable Pacific	8D-FB	Cable-ST2-01	2021/10/22	2022/10/21
Attenuator Mini-Circuits	UNAT-5+	PAD-ST2-01	2021/10/22	2022/10/21
ADT. Turn Table	TT100	0205	NA	NA
ADT. Tower	AT100	0205	NA	NA
Software BVADT	Radiated_V7.6.15.9.5	NA	NA	NA

- Note:
1. The calibration interval of the above test instruments is 12 months and the calibrations are traceable to NML/ROC and NIST/USA.
  2. The test was performed in Linkou Open Site2 , The test site validated date: 2021/07/30(NSA)
  3. The VCCI Site Registration No. R-10237.
  4. Tested Date: 2021/11/4

### 6.3 Test Arrangement

- The EUT was placed on the top of a rotating table 0.8 meters above the ground at an accredited test facility. The table was rotated 360 degrees to determine the position of the highest radiation.
- The EUT was set 10 meters away from the interference-receiving antenna, which was mounted on the top of a variable-height antenna tower.
- The antenna is a broadband antenna, and its height is varied from one meter to four meters above the ground to determine the maximum value of the field strength. Both horizontal and vertical polarizations of the antenna are set to make the measurement.
- For each suspected emission, the EUT was arranged to its worst case and then the antenna was tuned to heights from 1 meter to 4 meters and the rotatable table was turned from 0 degrees to 360 degrees to find the maximum reading.
- The test-receiver system was set to quasi-peak detect function and specified bandwidth with maximum hold mode when the test frequency is up to 1 GHz.

Note: The resolution bandwidth and video bandwidth of test receiver/spectrum analyzer is 120kHz for quasi-peak detection (QP) at frequency up to 1GHz.

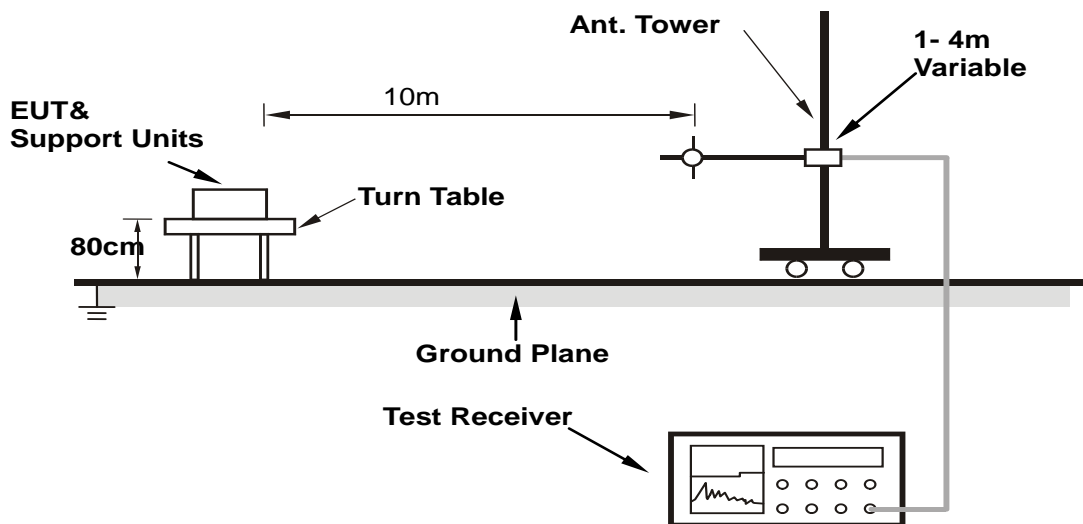

For the actual test configuration, please refer to the related item – Photographs of the Test Configuration.

## 6.4 Test Results

### Mode 1

Frequency Range	30MHz ~ 1GHz	Detector Function & Resolution Bandwidth	Quasi-Peak (QP), 120kHz
Tested By	Paul Chen	Environmental Conditions	24 °C, 56% RH

Antenna Polarity & Test Distance : Horizontal at 10 m								
No	Frequency (MHz)	Emission Level (dBuV/m)	Limit (dBuV/m)	Margin (dB)	Antenna Height (m)	Table Angle (Degree)	Raw Value (dBuV)	Correction Factor (dB/m)
1	62.19	28.04 QP	40.00	-11.96	4.00 H	125	39.27	-11.23
2	125.00	28.27 QP	40.00	-11.73	4.00 H	150	39.68	-11.41
3	154.00	29.41 QP	40.00	-10.59	4.00 H	320	38.91	-9.50
4	214.32	29.70 QP	40.00	-10.30	4.00 H	286	41.85	-12.15
5	249.98	32.55 QP	47.00	-14.45	3.77 H	284	42.49	-9.94
6	308.01	35.41 QP	47.00	-11.59	3.42 H	295	42.97	-7.56
<b>7</b>	<b>462.00</b>	<b>46.63 QP</b>	<b>47.00</b>	<b>-0.37</b>	<b>2.14 H</b>	<b>150</b>	<b>50.46</b>	<b>-3.83</b>
8	530.45	38.65 QP	47.00	-8.35	1.83 H	107	41.27	-2.62
9	616.01	37.15 QP	47.00	-9.85	1.38 H	228	37.20	-0.05
10	924.00	45.33 QP	47.00	-1.67	1.00 H	333	38.42	6.91
11	992.46	40.19 QP	47.00	-6.81	1.00 H	120	32.71	7.48

#### Remarks:

1. Emission Level(dBuV/m) = Raw Value(dBuV) + Correction Factor(dB/m)
2. Correction Factor(dB/m) = Antenna Factor (dB/m) + Cable Factor (dB)  
– Pre-Amplifier Factor (dB)
3. The other emission levels were very low against the limit.
4. Margin value = Emission level – Limit value

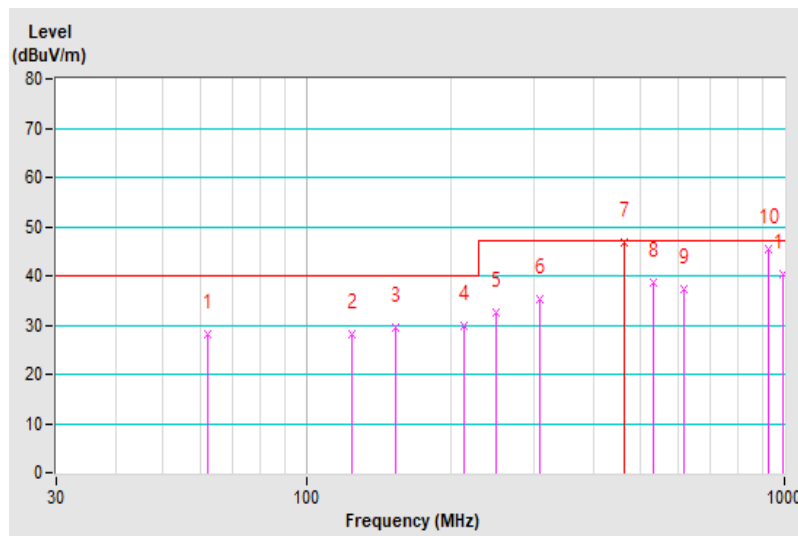

<b>Frequency Range</b>	30MHz ~ 1GHz	<b>Detector Function &amp; Resolution Bandwidth</b>	Quasi-Peak (QP), 120kHz
<b>Tested By</b>	Paul Chen	<b>Environmental Conditions</b>	24 °C, 56% RH

Antenna Polarity & Test Distance : Vertical at 10 m								
No	Frequency (MHz)	Emission Level (dBuV/m)	Limit (dBuV/m)	Margin (dB)	Antenna Height (m)	Table Angle (Degree)	Raw Value (dBuV)	Correction Factor (dB/m)
1	79.73	27.69 QP	40.00	-12.31	1.77 V	165	42.81	-15.12
2	114.75	30.02 QP	40.00	-9.98	1.00 V	295	42.41	-12.39
3	125.02	28.33 QP	40.00	-11.67	1.00 V	68	39.74	-11.41
4	154.00	36.08 QP	40.00	-3.92	1.00 V	8	45.58	-9.50
5	214.32	33.55 QP	40.00	-6.45	1.00 V	208	45.70	-12.15
6	250.00	32.67 QP	47.00	-14.33	1.00 V	342	42.61	-9.94
7	308.02	34.34 QP	47.00	-12.66	1.00 V	131	41.90	-7.56
8	462.00	43.23 QP	47.00	-3.77	1.00 V	63	47.06	-3.83
9	530.43	36.83 QP	47.00	-10.17	3.39 V	148	39.45	-2.62
10	616.01	33.36 QP	47.00	-13.64	3.23 V	279	33.41	-0.05
11	924.01	38.68 QP	47.00	-8.32	2.24 V	193	31.77	6.91
12	992.46	37.77 QP	47.00	-9.23	2.05 V	287	30.29	7.48

**Remarks:**

1. Emission Level(dBuV/m) = Raw Value(dBuV) + Correction Factor(dB/m)
2. Correction Factor(dB/m) = Antenna Factor (dB/m) + Cable Factor (dB) – Pre-Amplifier Factor (dB)
3. The other emission levels were very low against the limit.
4. Margin value = Emission level – Limit value

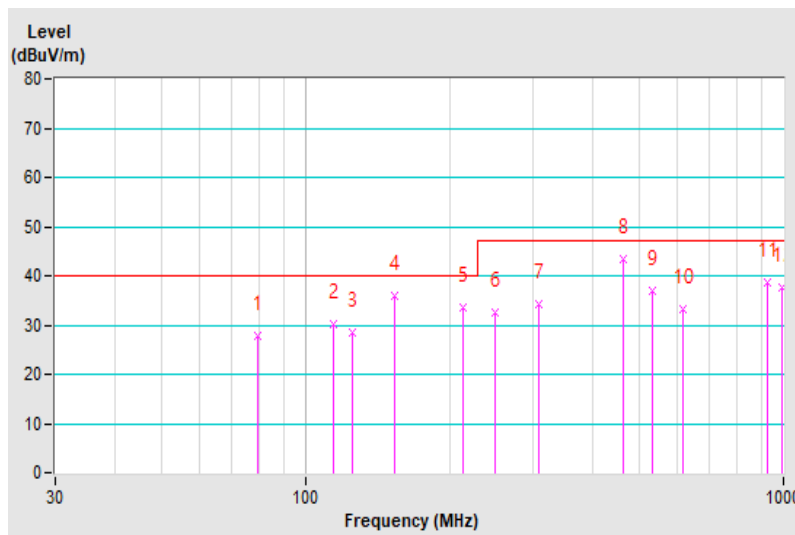

## 7 Radiated Disturbance above 1 GHz

### 7.1 Limits

Frequency (GHz)	dBuV/m (at 3m)	
	Average	Peak
1 to 3	56	76
3 to 6	60	80

- Notes: 1. The lower limit shall apply at the transition frequencies.  
 2. Emission level (dBuV/m) = 20 log Emission level (uV/m).  
 3. All emanations from a class A/B digital device or system, including any network of conductors and apparatus connected thereto, shall not exceed the level of field strengths specified above.

#### Frequency Range (For unintentional radiators)

Highest frequency generated or used in the EUT or on which the EUT operates or tunes (MHz)	Upper frequency of measurement range (MHz)
Below 108	1000
108-500	2000
500-1000	5000
Above 1000	Up to 5 times of the highest frequency or 6 GHz, whichever is less



## 7.2 Test Instruments

Description & Manufacturer	Model No.	Serial No.	Calibrated Date	Calibrated Until
Spectrum Analyzer Agilent	E4446A	MY51100009	2021/6/29	2022/6/28
Spectrum Keysight	N9020B	MY60110438	2020/12/2	2021/12/1
Test Receiver Agilent	N9038A	MY50010135	2021/5/28	2022/5/27
Pre-amplifier HP	8449B	3008A01292	2021/2/19	2022/2/18
Pre_Amplifier EMCI	EMC0126545	980076	2021/2/19	2022/2/18
Horn Antenna ETS-Lindgren	3117-PA	00215857	2020/11/22	2021/11/21
Horn Antenna EMCO	3115	9312-4192	2020/11/22	2021/11/21
Pre_Amplifier MITEQ	AMF-6F-260400-33-8P	892164	2021/2/19	2022/2/18
Pre_Amplifier EMCI	EMC184045B	980235	2021/2/19	2022/2/18
Horn Antenna Schwarzbeck	BBHA-9170	BBHA9170190	2020/11/22	2021/11/21
RF Coaxial Cable HUBER SUHNER	SF-102	Cable-CH7(3.6M)-02	2021/7/8	2022/7/7
Attenuator Mini-Circuits	BW-N4W5+	PAD-CH7-02	2021/7/8	2022/7/7
Attenuator Mini-Circuits	BW-K3-2W44+	PAD-CH7-03	2021/7/8	2022/7/7
BandPass Filter MICRO-TRONICS	BRM17690	005	2021/5/28	2022/5/27
Notch filter MICRO-TRONICS	BRC50703-01	010	2021/5/28	2022/5/27
Turn Table & Tower Max Full	MF7802	MF780208103	NA	NA
Software BVADT	Radiated_V8.7.08	NA	NA	NA

- Note:
1. The calibration interval of the above test instruments is 12 months and the calibrations are traceable to NML/ROC and NIST/USA.
  2. The test was performed in Linkou 966 Chamber 2 (CH 7).
  3. The VCCI Site Registration No. G-10039.
  4. Tested Date: 2021/11/4

### 7.3 Test Arrangement

- The EUT was placed on the top of a rotating table 0.8 meters above the ground at an accredited chamber room. The table was rotated 360 degrees to determine the position of the highest radiation.
- The EUT was set 3 meters away from the interference-receiving antenna, which was mounted on the top of a variable-height antenna tower.
- The height of antenna can be varied from one meter to four meters, the height of adjustment depends on the EUT height and the antenna 3dB beamwidth both, to detect the maximum value of the field strength. Both horizontal and vertical polarizations of the antenna are set to make the measurement.
- For each suspected emission, the EUT was arranged to its worst case and then the antenna was tuned to heights and the rotatable table was turned from 0 degrees to 360 degrees to find the maximum reading.
- The spectrum analyzer system was set to peak and average detect function and specified bandwidth with maximum hold mode when the test frequency is above 1 GHz.

Note: The resolution bandwidth of test receiver/spectrum analyzer is 1MHz and video bandwidth is 3MHz for Peak detection (PK) at frequency above 1GHz. The resolution bandwidth of test receiver/spectrum analyzer is 1 MHz for Average detection (AV) at frequency above 1GHz.

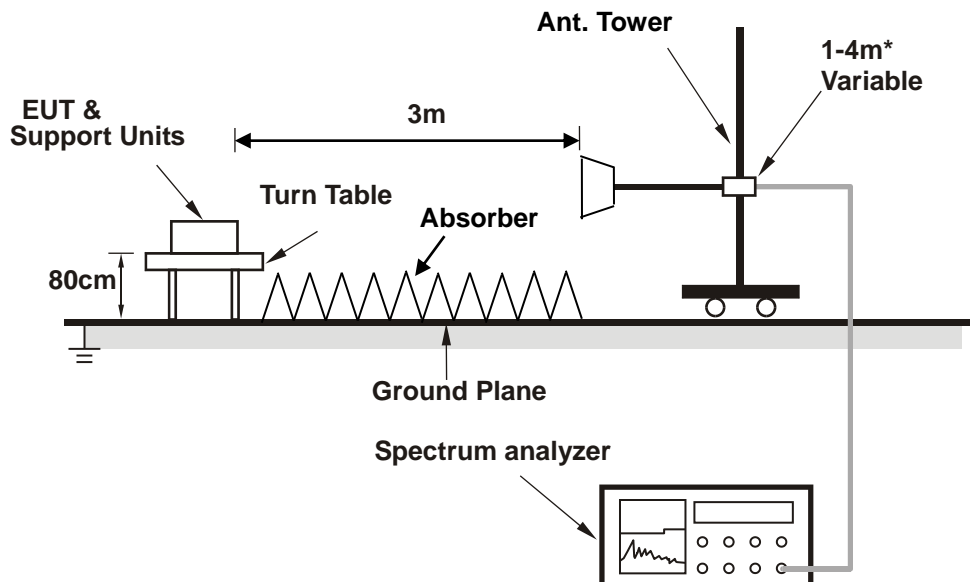

\* :depends on the EUT height and the antenna 3dB beamwidth both.

For the actual test configuration, please refer to the related item – Photographs of the Test Configuration.

## 7.4 Test Results

### Mode 1

Frequency Range	1GHz ~ 6GHz	Detector Function & Resolution Bandwidth	Peak (PK) / Average (AV), 1MHz
Tested By	Vincent Lin	Environmental Conditions	24 °C, 62% RH

Antenna Polarity & Test Distance : Horizontal at 3 m								
No	Frequency (MHz)	Emission Level (dBuV/m)	Limit (dBuV/m)	Margin (dB)	Antenna Height (m)	Table Angle (Degree)	Raw Value (dBuV)	Correction Factor (dB/m)
1	1231.97	58.76 PK	76.00	-17.24	1.00 H	35	62.83	-4.07
2	1231.97	45.80 AV	56.00	-10.20	1.00 H	35	49.87	-4.07
3	1694.03	54.03 PK	76.00	-21.97	1.78 H	121	56.82	-2.79
<b>4</b>	<b>1694.03</b>	<b>50.31 AV</b>	<b>56.00</b>	<b>-5.69</b>	<b>1.78 H</b>	<b>121</b>	<b>53.10</b>	<b>-2.79</b>
5	1799.05	57.59 PK	76.00	-18.41	1.98 H	336	59.14	-1.55
6	1799.05	35.07 AV	56.00	-20.93	1.98 H	336	36.62	-1.55
7	2151.87	56.80 PK	76.00	-19.20	2.50 H	360	56.72	0.08
8	2151.87	36.25 AV	56.00	-19.75	2.50 H	360	36.17	0.08
9	2957.72	53.40 PK	76.00	-22.60	1.19 H	153	51.83	1.57
10	2957.72	35.19 AV	56.00	-20.81	1.19 H	153	33.62	1.57
11	3695.99	60.94 PK	80.00	-19.06	1.48 H	16	57.64	3.30
12	3695.99	52.43 AV	60.00	-7.57	1.48 H	16	49.13	3.30

#### Remarks:

1. Emission Level(dBuV/m) = Raw Value(dBuV) + Correction Factor(dB/m)
2. Correction Factor(dB/m) = Antenna Factor (dB/m) + Cable Factor (dB)  
– Pre-Amplifier Factor (dB)
3. The other emission levels were very low against the limit.
4. Margin value = Emission level – Limit value

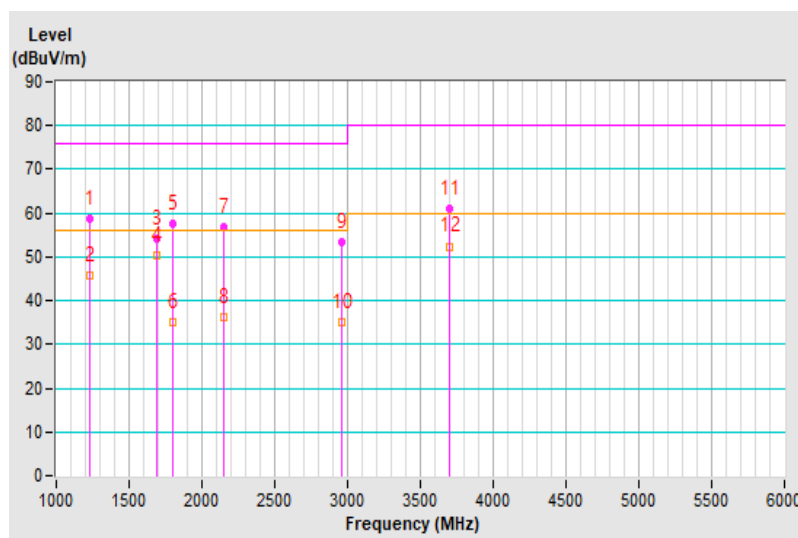

<b>Frequency Range</b>	1GHz ~ 6GHz	<b>Detector Function &amp; Resolution Bandwidth</b>	Peak (PK) / Average (AV), 1MHz
<b>Tested By</b>	Vincent Lin	<b>Environmental Conditions</b>	24 °C, 62% RH

Antenna Polarity & Test Distance : Vertical at 3 m								
No	Frequency (MHz)	Emission Level (dBuV/m)	Limit (dBuV/m)	Margin (dB)	Antenna Height (m)	Table Angle (Degree)	Raw Value (dBuV)	Correction Factor (dB/m)
1	1077.94	58.45 PK	76.00	-17.55	1.05 V	210	63.75	-5.30
2	1077.94	49.38 AV	56.00	-6.62	1.05 V	210	54.68	-5.30
3	1231.97	55.84 PK	76.00	-20.16	1.47 V	191	60.36	-4.52
4	1231.97	43.03 AV	56.00	-12.97	1.47 V	191	47.55	-4.52
5	1896.59	50.98 PK	76.00	-25.02	2.18 V	32	52.20	-1.22
6	1896.59	38.03 AV	56.00	-17.97	2.18 V	32	39.25	-1.22
7	2757.91	49.01 PK	76.00	-26.99	2.29 V	294	49.85	-0.84
8	2757.91	34.65 AV	56.00	-21.35	2.29 V	294	35.49	-0.84
9	2946.77	51.88 PK	76.00	-24.12	2.34 V	192	51.55	0.33
10	2946.77	35.22 AV	56.00	-20.78	2.34 V	192	34.89	0.33
11	3541.94	57.27 PK	80.00	-22.73	2.00 V	10	55.33	1.94
12	3541.94	46.84 AV	60.00	-13.16	2.00 V	10	44.90	1.94

**Remarks:**

1. Emission Level(dBuV/m) = Raw Value(dBuV) + Correction Factor(dB/m)
2. Correction Factor(dB/m) = Antenna Factor (dB/m) + Cable Factor (dB) – Pre-Amplifier Factor (dB)
3. The other emission levels were very low against the limit.
4. Margin value = Emission level – Limit value

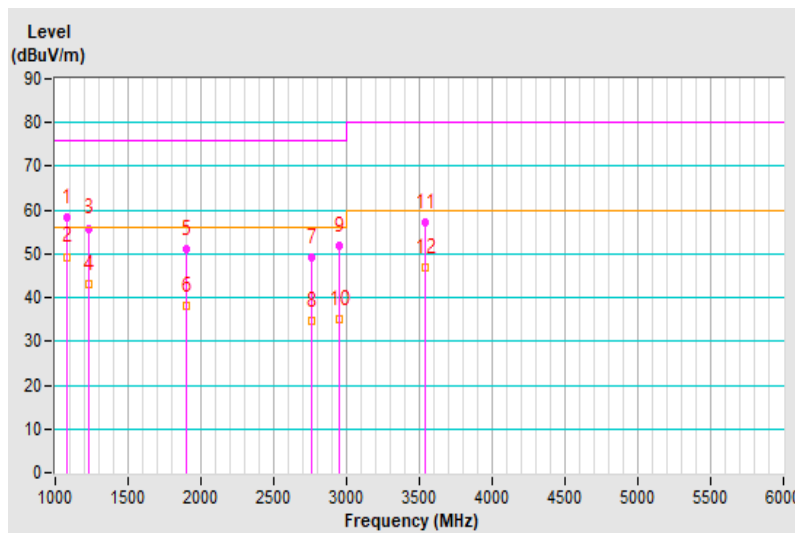

## 8 Harmonics Current Measurement

### 8.1 Limits

Limits for Class A equipment		Limits for Class D equipment		
Harmonic Order n	Max. permissible harmonics current A	Harmonic Order n	Max. permissible harmonics current per watt mA/W	Max. permissible harmonics current A
Odd harmonics		Odd Harmonics only		
3	2.30	3	3.4	2.30
5	1.14	5	1.9	1.14
7	0.77	7	1.0	0.77
9	0.40	9	0.5	0.40
11	0.33	11	0.35	0.33
13	0.21	13	0.30	0.21
15 ≤ n ≤ 39	0.15 x 15/n	15 ≤ n ≤ 39	3.85/n	0.15 x 15/n
Even harmonics				
2	1.08			
4	0.43			
6	0.30			
8 ≤ n ≤ 40	0.23 x 8/n			

- Notes: 1. Class A and Class D are classified according to section 5 of EN 61000-3-2.  
 2. According to section 7 of EN 61000-3-2, the above limits for all equipment except for lighting equipment having an active input power > 75 W and no limits apply for equipment with an active input power up to and including 75 W.

### 8.2 Classification of Equipment

Class A	Class B	Class C	Class D
Balanced three-phase equipment; Household appliances excluding equipment as Class D; Tools excluding portable tools; Dimmers for incandescent lamps; Audio equipment; Equipment not specified in one of the three other classes.	Portable tools; Arc welding equipment which is not professional equipment.	Lighting equipment.	Equipment having a specified power less than or equal to 600 W of the following types: Personal computers and personal computer monitors; Television receivers; Refrigerators and freezers having one or more variable-speed drives to control compressor motor(s).

### 8.3 Test Instruments

Description & Manufacturer	Model No.	Serial No.	Calibrated Date	Calibrated Until
Harmonics and Flicker Analyzer TESEQ	PROFLINE 2105	1632A00983&1639A01863	2021/6/8	2022/6/7
Software	CTS 4	NA	NA	NA

- Note: 1. The calibration interval of the above test instruments is 12 months and the calibrations are traceable to NML/ROC and NIST/USA.  
 2. The test was performed in EMS Room No. 1.  
 3. Tested Date: 2021/11/15

## 8.4 Test Arrangement

- The EUT was placed on the top of a wooden table 0.8 meters above the ground and operated to produce the maximum harmonic components under normal operating conditions for each successive harmonic component in turn.
- The correspondent test program of test instrument to measure the current harmonics emanated from EUT is chosen. The measure time shall be not less than the time necessary for the EUT to be exercised.

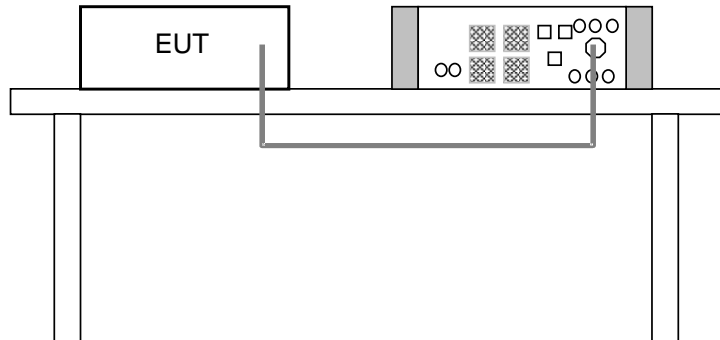

For the actual test configuration, please refer to the related item – Photographs of the Test Configuration.

## 8.5 Test Results

### Mode 1

<b>Test Duration</b>	5 min	<b>Fundamental Voltage / Ampere</b>	230.63 Vrms / 0.277 Arms
<b>Power Consumption</b>	20.6 W	<b>Power Frequency</b>	50 Hz
<b>Power Factor</b>	0.330	<b>Environmental Conditions</b>	25 °C, 70% RH
<b>Tested By</b>	Chiming Li		

Notes:

- Limits are not specified for equipment with a rated power of 75W or less (other than lighting equipment).
- According to EN 61000-3-2 the manufacturer shall specify the power of the apparatus. This value shall be used for establishing limits. The specified power shall be within +/-10% of the measured power.

## 9 Voltage Fluctuations and Flicker Measurement

### 9.1 Limits

Test item	Limit	Note
$P_{st}$	1.0	$P_{st}$ : short-term flicker severity.
$P_{lt}$	0.65	$P_{lt}$ : long-term flicker severity.
$T_{max}$ (ms)	500	$T_{max}$ : maximum time duration during the observation period that the voltage deviation $d(t)$ exceeds the limit for $d_c$ .
$d_{max}$ (%)	4	$d_{max}$ : maximum absolute voltage change during an observation period.
$d_c$ (%)	3.3	$d_c$ : maximum steady state voltage change during an observation period.

### 9.2 Test Instruments

Description & Manufacturer	Model No.	Serial No.	Calibrated Date	Calibrated Until
Harmonics and Flicker Analyzer TESEQ	PROFLINE 2105	1632A00983&163 9A01863	2021/6/8	2022/6/7
Software	CTS 4	NA	NA	NA

- Note:
1. The calibration interval of the above test instruments is 12 months and the calibrations are traceable to NML/ROC and NIST/USA.
  2. The test was performed in EMS Room No. 1.
  3. Tested Date: 2021/11/15

### 9.3 Test Arrangement

- a. The EUT was placed on the top of a wooden table 0.8 meters above the ground and operated to produce the most unfavorable sequence of voltage changes under normal operating conditions.
- b. During the flick measurement, the measure time shall include that part of whole operation cycle in which the EUT produce the most unfavorable sequence of voltage changes. The observation period for short-term flicker indicator is 10 minutes and the observation period for long-term flicker indicator is 2 hours.

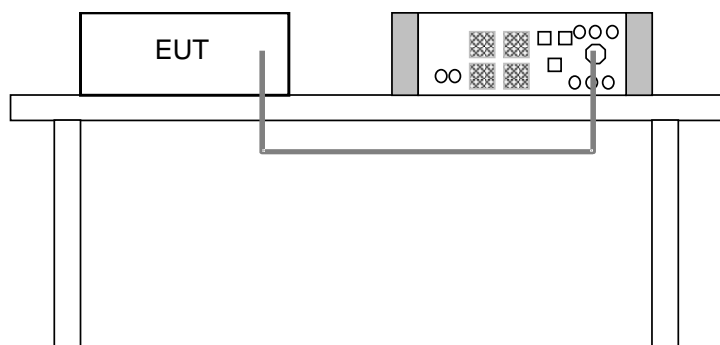

For the actual test configuration, please refer to the related item – Photographs of the Test Configuration.

## 9.4 Test Results

### Mode 1

<b>Observation (Tp)</b>	10 min		
<b>Input Power</b>	230Vac,50Hz	<b>Environmental Conditions</b>	25 °C, 70% RH
<b>Tested By</b>	Chiming Li		

Test Parameter	Measurement Value	Limit	Remarks
$P_{st}$	0.319	1.00	Pass
$P_{lt}$	0.139	0.65	Pass
$T_{max}$ (ms)	0.000	500	Pass
$d_{max}$ (%)	0.000	4.00	Pass
$d_c$ (%)	0.000	3.30	Pass

Notes:

1.  $P_{st}$  means short-term flicker indicator.
2.  $P_{lt}$  means long-term flicker indicator.
3.  $T_{max}$  means accumulated time value of  $d(t)$  with a deviation exceeding 3.3 %.
4.  $d_{max}$  means maximum relative voltage change.
5.  $d_c$  means maximum relative steady-state voltage change.



## 10 Electrostatic Discharge Immunity Test (ESD)

### 10.1 Test Specification

<b>Basic Standard:</b>	EN 61000-4-2
<b>Discharge Impedance:</b>	330 ohm / 150 pF
<b>Discharge Voltage:</b>	Air Discharge: $\pm 2, \pm 4, \pm 8$ kV (Direct) Contact Discharge: $\pm 2, \pm 4, \pm 6$ kV (Indirect & Direct )
<b>Number of Discharge:</b>	Minimum 20 times at each test point
<b>Discharge Mode:</b>	Single Discharge
<b>Discharge Period:</b>	1-second minimum

### 10.2 Test Instruments

Description & Manufacturer	Model No.	Serial No.	Calibrated Date	Calibrated Until
ESD Simulator KeyTek	MZ15/EC	0504259	2021/11/10	2022/11/9
ESD Simulator KeyTek	MZ-15/EC	0401299	2021/10/7	2022/10/6
ESD Simulator TESEQ	NSG 438	1364	2020/12/11	2021/12/10
Electronic Discharge Simulator Noiseken	ESS-2000	ESS0382041	2021/10/7	2022/10/6
ESD Generator EM Test	Dito//DM-150/330//DM-150/330-rfci	P1315117252/P1317117852	2021/7/9	2022/7/8

Note: 1. The calibration interval of the above test instruments is 12 months and the calibrations are traceable to NML/ROC and NIST/USA.  
2. The test was performed in ESD Room No. 1.  
3. Tested Date: 2021/11/16

### 10.3 Test Arrangement

- a. Electrostatic discharges were applied only to those points and surfaces of the EUT that are accessible to users during normal operation.
- b. The test was performed with at least ten single discharges on the pre-selected points in the most sensitive polarity.
- c. The time interval between two successive single discharges was at least 1 second.
- d. The ESD generator was held perpendicularly to the surface to which the discharge was applied and the return cable was at least 0.2 meters from the EUT.
- e. Contact discharges were applied to the non-insulating coating, with the pointed tip of the generator penetrating the coating and contacting the conducting substrate.
- f. Air discharges were applied with the round discharge tip of the discharge electrode approaching the EUT as fast as possible (without causing mechanical damage) to touch the EUT. After each discharge, the ESD generator was removed from the EUT and re-triggered for a new single discharge. The test was repeated until all discharges were complete.
- g. At least ten single discharges (in the most sensitive polarity) were applied to the **Horizontal Coupling Plane** at points on each side of the EUT. The ESD generator was positioned at a distance of 0.1 meters from the EUT with the discharge electrode touching the **HCP**.

- h. At least ten single discharges (in the most sensitive polarity) were applied to the center of one vertical edge of the **Vertical Coupling Plane** in sufficiently different positions that the four faces of the EUT were completely illuminated. The **VCP** (dimensions 0.5m x 0.5m) was placed vertically to and 0.1 meters from the EUT.

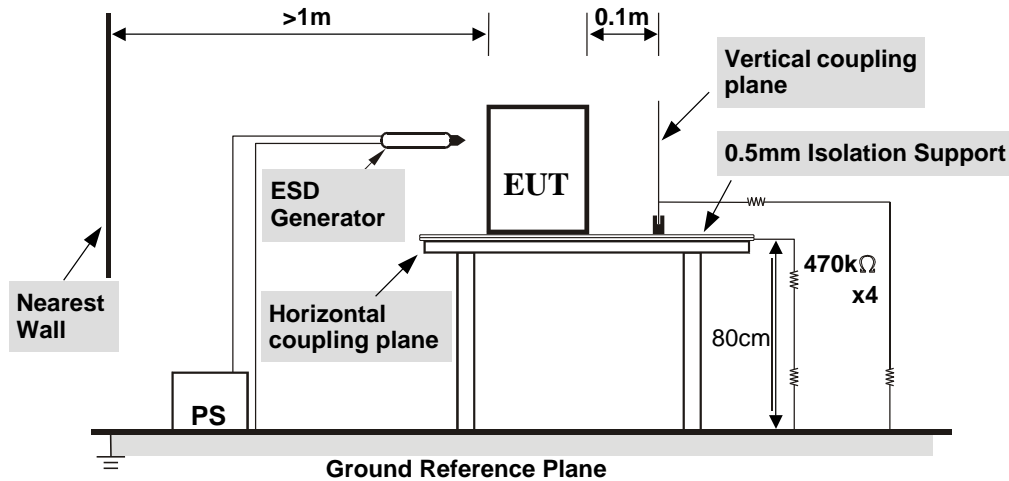

#### TABLE-TOP EQUIPMENT

The configuration consisted of a wooden table 0.8 meters high standing on the **Ground Reference Plane**. The **GRP** consisted of a sheet of aluminum at least 0.25mm thick, and 2.5 meters square connected to the protective grounding system. A **Horizontal Coupling Plane** (1.6m x 0.8m) was placed on the table and attached to the **GRP** by means of a cable with 940kΩ total impedance. The equipment under test, was installed in a representative system as described in section 7 of EN 61000-4-2, and its cables were placed on the **HCP** and isolated by an insulating support of 0.5mm thickness. A distance of 1-meter minimum was provided between the EUT and the walls of the laboratory and any other metallic structure.

For the actual test configuration, please refer to the related item – Photographs of the Test Configuration.

## 10.4 Test Results

### Mode 1

Input Power	230Vac, 50 Hz	Tested by	Chiming Li
Environmental Conditions	23°C, 56% RH, 1006 mbar		

#### Test Results of Direct Application

Discharge Level (kV)	Polarity (+/-)	Test Point	Contact Discharge	Air Discharge	Performance Criterion
2, 4, 6	+/-	8, 9, 11, 12, 15	Note 1	NA	A
2, 4	+/-	1-7, 10, 13, 14, 16	NA	Note 1	A
8	+/-	4-7, 10, 13, 14, 16	NA	Note 1	A
8	+/-	1, 2, 3	NA	Note 2	B

Description of test points of direct application: Please refer to following page for representative mark only.

#### Test Results of Indirect Application

Discharge Level (kV)	Polarity (+/-)	Test Point	Horizontal Coupling Plane	Vertical Coupling Plane	Performance Criterion
2, 4, 6	+/-	Four Sides	Note 1	Note 1	A

Description of test points of indirect application:

1. Front side                      2. Rear side                      3. Right side                      4. Left side

- Note: 1. The EUT is operated normal during the test.  
 2. There were flickered disturbance from DP output screen during the test, but could self-recover after the test.

### Description of Test Points

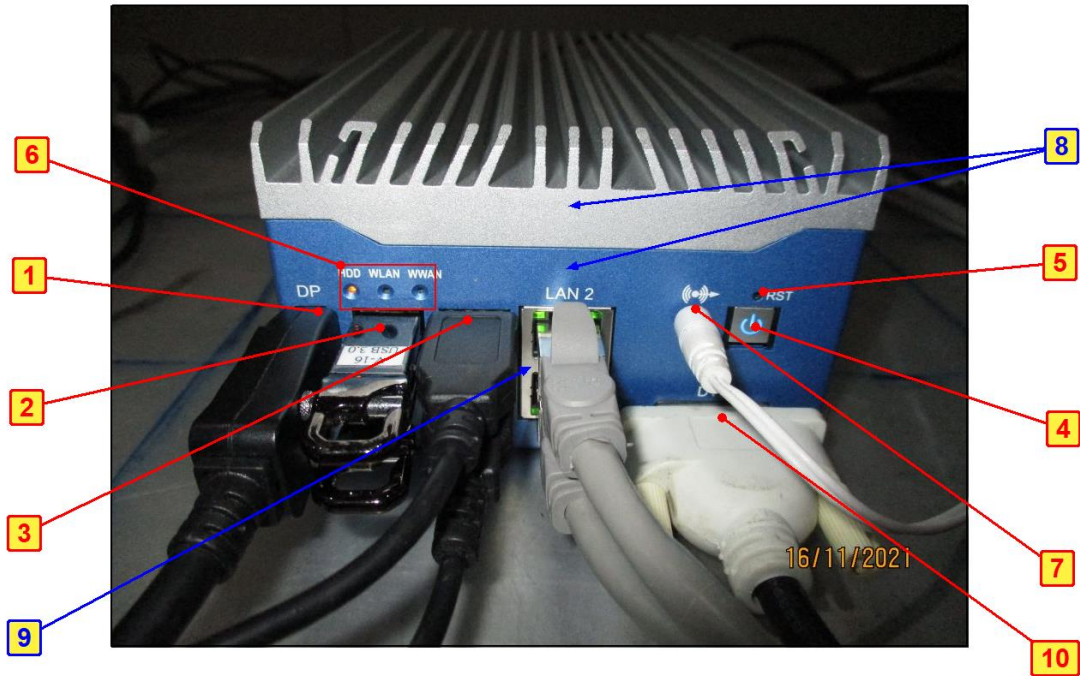

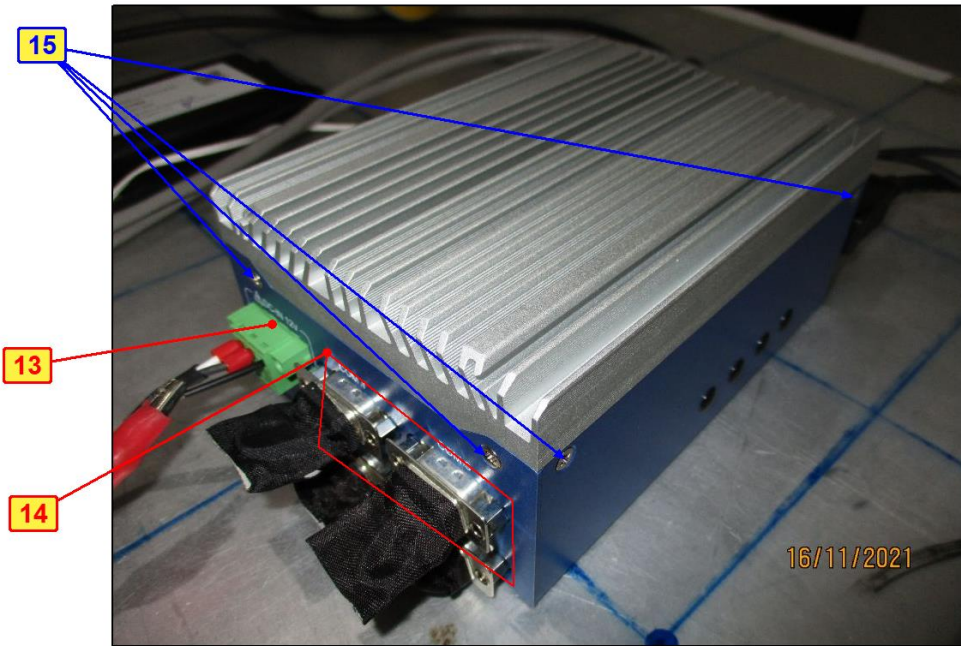

## 11 Radio-frequency Electromagnetic Field Immunity Test (RS)

### 11.1 Test Specification

Basic Standard:	EN 61000-4-3
Frequency Range, Field Strength:	80-800 MHz, 20V/m <sup>1</sup>
	800-1000 MHz, 20V/m
	1400-2000 MHz, 10V/m
	2000-2700 MHz, 5V/m
Modulation:	5100-6000 MHz, 3V/m
	1kHz Sine Wave, 80%, AM Modulation
Frequency Step:	1 % of preceding frequency value
Polarity of Antenna:	Horizontal and Vertical
Antenna Height:	1.5m
Dwell Time:	3 seconds

Note 1: This limit applies to equipment mounted in the passenger compartments, drivers cab or external to the rolling stock (roof, underframe). For equipment mounted in all other areas a severity level of 10 V/m may be used.

## 11.2 Test Instruments

Description & Manufacturer	Model No.	Serial No.	Calibrated Date	Calibrated Until
Signal Generator Agilent	E8257D	MY48050465	2021/6/22	2022/6/21
Amplifier BONN	BSA 0125-800	1912556	NA	NA
Amplifier TESTQ	CBA 1G-275	T44344	NA	NA
Power Amplifier AR	35S4G8AM4	0326094	NA	NA
Power Amplifier AR	100S1G4M3	0329249	NA	NA
Controller AR	SC1000M3	305910	NA	NA
RF Power meter BOONTON	4232A	10180	2021/5/24	2022/5/23
Power sensor BOONTON	51011-EMC	34152	2021/5/24	2022/5/23
Power sensor BOONTON	51011-EMC	34153	2021/5/24	2022/5/23
Log-Periodic Antenna AR	AT6080	0329465	NA	NA
BiconiLog Antenna EMCO	3141	1001	NA	NA
High Gain Horn Antenna AR	AT4010	0329800	NA	NA
LOG ANTENNA Schwarzbeck	Schwarzbeck Stlp 9149	9149-260	NA	NA
CHANCE MOST Full Anechoic Chamber (9x5x3m)	Chance Most	RS-002	2021/2/4	2022/2/3
Software BVADT	RS_V7.6	NA	NA	NA
Audio analyzer R&S	UPV	104565	2021/5/18	2022/5/17
Ear Simulator Telephonometry B&K	4185	2553594	NA	NA
Pressure-field Microphone B&K	4192	3190854	2021/1/7	2022/1/6
Two channel microphone conditioning amplifier B&K	2690 A OS2	2645274	2021/5/16	2022/5/15
POWER AMPLIFIER B&K	2716C	2610979	NA	NA
Mouth Simulator B&K	4227	2630632	NA	NA
Software	ABMS_ V7.4.3	NA	NA	NA

Note: 1. The calibration interval of the above test instruments is 12 months and the calibrations are traceable to NML/ROC and NIST/USA.  
 2. The test was performed in RS Room No.2.  
 3. Tested Date: 2021/11/17

### 11.3 Test Arrangement

The test procedure was in accordance with EN 61000-4-3.

- a. The testing was performed in a fully anechoic chamber.
- b. The frequency ranges and field strength levels are 80-800 MHz, 20V/m, 800-1000 MHz, 20V/m, 1400-2000 MHz, 10V/m, 2000-2700 MHz, 5V/m and 5100-6000 MHz, 3V/m with the signal 80% amplitude modulated with a 1kHz sine wave.
- c. The test was performed with the EUT exposed to both vertically and horizontally polarized fields on each of the four sides.

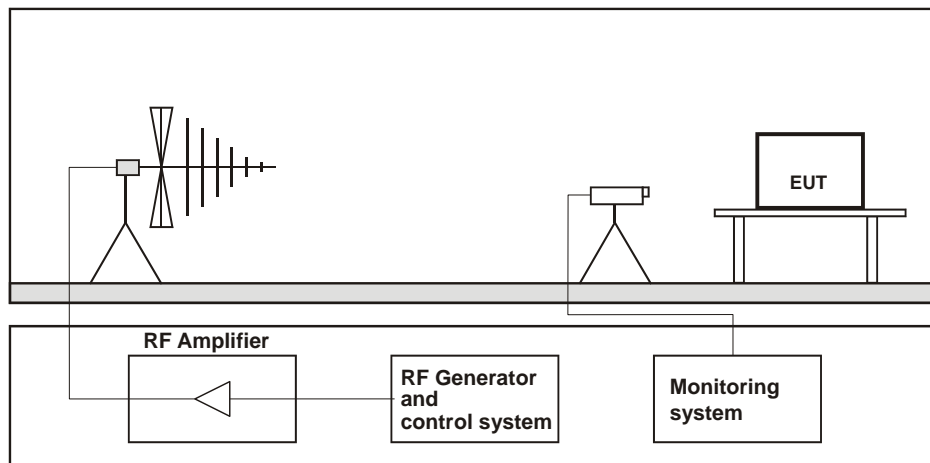

#### Table-top Equipment

The EUT installed in a representative system as described in section 7 of EN 61000-4-3 was placed on a non-conductive table 0.8 meters in height. The system under test was connected to the power and signal wire according to relevant installation instructions.

For the actual test configuration, please refer to the related item – Photographs of the Test Configuration.



## 11.4 Test Results

### Mode 1

Input Power	230Vac, 50 Hz	Tested by	Joey Liu
Environmental Conditions	25°C, 75% RH		

Frequency (MHz)	Polarity	Azimuth(°)	Applied Field Strength		Test Distance (m)	Observation	Performance Criterion
			(V/m)	Modulation			
80 - 800	V&H	0, 90, 180, 270	20	80% AM (1kHz)	3	Note	A
800 - 1000	V&H	0, 90, 180, 270	20	80% AM (1kHz)	3	Note	A
1400 - 2000	V&H	0, 90, 180, 270	10	80% AM (1kHz)	3	Note	A
2000 - 2700	V&H	0, 90, 180, 270	5	80% AM (1kHz)	3	Note	A
5100 - 6000	V&H	0, 90, 180, 270	3	80% AM (1kHz)	3	Note	A

Note: The EUT is operated normal during the test.

## 12 Electrical Fast Transient/Burst Immunity Test (EFT)

### 12.1 Test Specification

Basic Standard:	EN 61000-4-4
Test Voltage:	Signal & communication, process measurement & control ports: $\pm 2\text{kV}$ , Capacitive clamp Battery referenced ports (except at the output of energy sources), Auxiliary a.c. power input ports (rated voltage $\leq 400\text{ Vrms}$ ): $\pm 2\text{kV}$
Impulse Repetition Frequency:	5kHz
Impulse Wave Shape:	5/50 ( $T_r/T_h$ ) ns
Burst Duration:	15 ms
Burst Period:	300 ms
Test Duration:	1 min.

### 12.2 Test Instruments

Description & Manufacturer	Model No.	Serial No.	Calibrated Date	Calibrated Until
Burst generator Haefely	PEFT 4010	154954	2021/4/7	2022/4/6

- Note:
1. The calibration interval of the above test instruments is 12 months and the calibrations are traceable to NML/ROC and NIST/USA.
  2. The test was performed in EFT Room.
  3. Tested Date: 2021/10/26

### 12.3 Test Arrangement

- Both positive and negative polarity discharges were applied.
- The distance between any coupling devices and the EUT should be 0.5 m for table-top equipment testing, and 1.0 m for floor standing equipment.
- The duration time of each test sequential was 1 minute.
- The transient/burst waveform was in accordance with EN 61000-4-4, 5/50 ns.

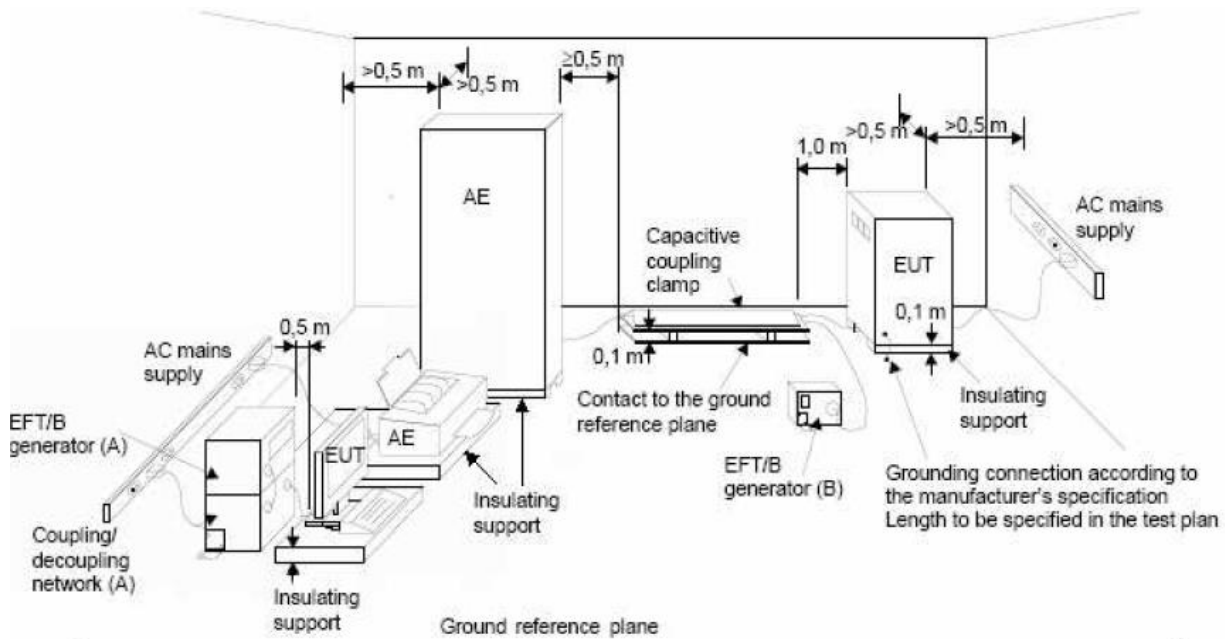

**NOTE:**

- location for supply line coupling
- location for signal lines coupling

For the actual test configuration, please refer to the related item – Photographs of the Test Configuration.

## 12.4 Test Results

### Mode 1

Input Power	230Vac, 50 Hz	Tested by	Chiming Li
Environmental Conditions	24°C, 69% RH		

Battery referenced ports (except at the output of energy sources),  
 Auxiliary a.c. power input ports (rated voltage  $\leq$  400 Vrms)

Voltage (kV)	Test Point	Polarity (+/-)	Observation	Performance Criterion
2	L	+/-	Note	A
2	N	+/-	Note	A
2	PE	+/-	Note	A
2	L-N-PE	+/-	Note	A

Signal & communication, process measurement & control ports

Voltage (kV)	Test Point	Polarity (+/-)	Observation	Performance Criterion
2	LAN (port 1) - Shielding	+/-	Note	A
2	LAN (port 2) - Shielding	+/-	Note	A

Note: The EUT is operated normal during the test.

## 13 Surge Immunity Test

### 13.1 Test Specification

Basic Standard:	EN 61000-4-5
Wave-Shape:	Battery referenced ports (except at the output of energy sources), Auxiliary a.c. power input ports (rated voltage $\leq 400$ Vrms): 1.2/50 $\mu$ s Open Circuit Voltage 8/20 $\mu$ s Short Circuit Current
Test Voltage:	Line to line: $\pm 0.5$ kV, $\pm 1$ kV, Line to ground: $\pm 0.5$ kV, $\pm 1$ kV, $\pm 2$ kV output impedance of 42 $\Omega$ (40 $\Omega$ and 2 $\Omega$ generator) and a coupling capacitance of 0,5 $\mu$ F
AC Phase Angle (degree):	0°, 90°, 180°, 270°
Pulse Repetition Rate:	1 time / 20 sec.
Number of Tests:	5 positive and 5 negative at selected points

### 13.2 Test Instruments

Description & Manufacturer	Model No.	Serial No.	Calibrated Date	Calibrated Until
Surge&EFT Generators TESEQ	NSG 3060	1572	2021/4/24	2022/4/23
Coupling Decoupling Network	CDN-UTP8	045	NA	NA
Coupling Decoupling Network TESEQ	CDN HSS-2	41009	NA	NA
Surge Coupling Decoupling Network TESEQ	CDN 118-T8	40386	2021/9/9	2022/9/8
CDN for Unshielded Unsymmetrical Signal & Data Lines TESEQ	CDN117	40144	2021/9/9	2022/9/8

- Note:
1. The calibration interval of the above test instruments is 12 months and the calibrations are traceable to NML/ROC and NIST/USA.
  2. The test was performed in Linkou EMS 02.
  3. Tested Date: 2021/11/17

### 13.3 Test Arrangement

The surge is to be applied to the EUT power supply terminals via the capacitive coupling network. Decoupling networks are required in order to avoid possible adverse effects on equipment not under test that may be powered by the same lines, and to provide sufficient decoupling impedance to the surge wave. The power cord between the EUT and the coupling/decoupling networks shall be 2 meters in length (or shorter).

For double-insulated products without PE or external earth connections, the test shall be done in a similar way as for grounded products but without adding any additional external grounded connections. If there are no other possible connections to earth, line-to-ground tests may be omitted.

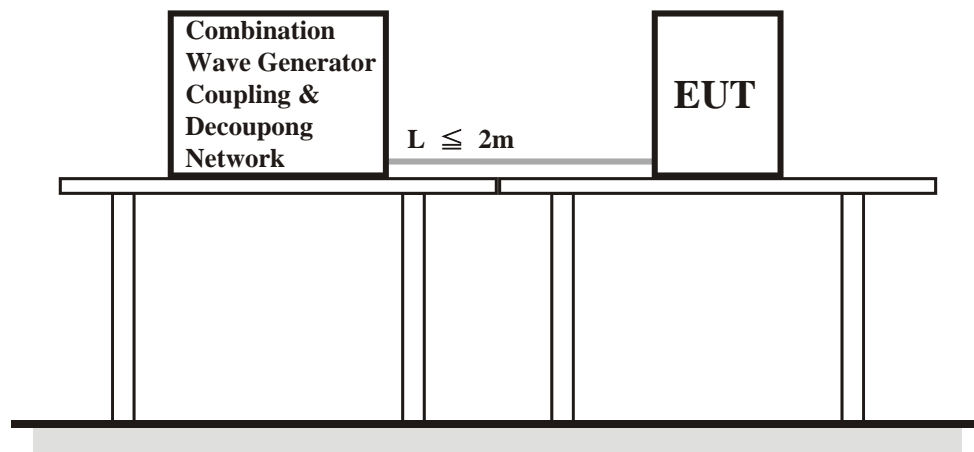

For the actual test configuration, please refer to the related item – Photographs of the Test Configuration.

### 13.4 Test Results

#### Mode 1

Input Power	230Vac, 50 Hz	Tested by	Chiming Li
Environmental Conditions	24°C, 69% RH		

Battery referenced ports (except at the output of energy sources),  
 Auxiliary a.c. power input ports (rated voltage  $\leq 400$  Vrms)

Voltage (kV)	Test Point	Polarity (+/-)	Observation	Performance Criterion
0.5, 1	L-N	+/-	Note	A
0.5, 1, 2	L-PE	+/-	Note	A
0.5, 1, 2	N-PE	+/-	Note	A

Note: The EUT is operated normal during the test.

## 14 Immunity to Conducted Disturbances Induced by RF Fields (CS)

### 14.1 Test Specification

Basic Standard:	EN 61000-4-6
Frequency Range:	0.15 MHz - 80 MHz
Voltage Level:	Battery referenced ports (except at the output of energy sources), Auxiliary a.c. power input ports (rated voltage $\leq$ 400 Vrms), Signal & communication, process measurement & control ports: 10 V
Modulation:	1kHz Sine Wave, 80%, AM Modulation
Frequency Step:	1 % of preceding frequency value
Dwell Time	3 seconds

### 14.2 Test Instruments

Description & Manufacturer	Model No.	Serial No.	Calibrated Date	Calibrated Until
R&S SML03 S.G R&S	SML03	101801	2021/1/13	2022/1/12
Amplifier AR	75A250AM1	306331	NA	NA
Digital Sweep Function Generator Topward	8120	984801	NA	NA
Power Sensor R & S	NRV-Z5	837878/039	2021/10/19	2022/10/18
Power Meter R & S	NRVD	837794/040	2021/10/19	2022/10/18
FCC EM Injection Clamp FCC	F-203I-23mm	455	NA	NA
Current Clamp FCC	F-120-9A	361	2021/8/8	2022/8/7
Coupling/Dcoupling Network EM TEST	CDN M1/32A	306508	2021/6/17	2022/6/16
CDN M2-16Amp FCC	FCC-801-M2-16A	01047	2021/6/17	2022/6/16
Coupling/Dcoupling Network TESEQ	CDN M232	37702	2021/6/17	2022/6/16
Coupling/Dcoupling Network TESEQ	CDN M332	41258	2021/6/17	2022/6/16
Coupling/Dcoupling Network TESEQ	CDN M332	41256	2021/6/17	2022/6/16
Coupling Decoupling Network TESEQ	CDN M432S	56519	2021/2/25	2022/2/24
CDN FCC	FCC-801-M5-50A	100018	2021/1/19	2022/1/18
Coupling Decoupling Network TESEQ	CDN T2A-10	54942	2021/2/25	2022/2/24
Coupling Decoupling Network TESEQ	CDN T400A	49918	2021/2/25	2022/2/24
Coupling Decoupling Network TESEQ	CDN T800	34428	2021/6/17	2022/6/16
Coupling Decoupling Network TESEQ	CDN T8-10	40376	2021/6/17	2022/6/16
Coupling Decoupling Network TESEQ	CDN T8-230	56641	2021/2/25	2022/2/24
Coupling Decoupling Network TESEQ	CDN T8-230	56642	2021/2/25	2022/2/24

Coupling Decoupling Network TESEQ	CDN T8-230	56643	2021/2/25	2022/2/24
CDN Calibration Kit TESEQ	CDN T8S	29459	2021/6/17	2022/6/16
Coupling Decoupling Network TESEQ	CDN ST08A	56527	2021/2/25	2022/2/24
Coupling Decoupling Network TESEQ	CDN ST08A	56525	2021/2/25	2022/2/24
CDN TESEQ	CDN S200	53490	2021/5/26	2022/5/25
CDN TESEQ	CDN S400	52115	2021/6/17	2022/6/16
Coupling Decoupling Network TESEQ	CDN S751A	56435	2021/2/25	2022/2/24
Coupling Decoupling Network TESEQ	CDN S751A	56436	2021/2/25	2022/2/24
Software BVADT	CS_V7.4.2	NA	NA	NA
Audio analyzer R&S	UPV	104565	2021/5/18	2022/5/17
Ear Simulator Telephonometry B&K	4185	2553594	NA	NA
Pressure-field Microphone B&K	4192	3073928	2021/8/12	2022/8/11
Two channel microphone conditioning amplifier B&K	2690 OS2	3001996	2021/11/17	2022/11/16
POWER AMPLIFIER B&K	2716C	2610979	NA	NA
Mouth Simulator B&K	4227	2630632	NA	NA
Software BVADT	ABMS_V7.4.3	NA	NA	NA

- Note:
1. The calibration interval of the above test instruments is 12 months and the calibrations are traceable to NML/ROC and NIST/USA.
  2. The test was performed in Linkou CS 01.
  3. Tested Date: 2021/12/15



### 14.3 Test Arrangement

- The EUT shall be tested within its intended operating and climatic conditions.
- An artificial hand was placed on the hand-held accessory and connected to the ground reference plane.
- One of the CDNs not used for injection was terminated with 50 ohm, providing only one return path. All other CDNs were coupled as decoupling networks.
- The frequency range is swept from 150 kHz to 80 MHz, using the signal level established during the setting process and with a disturbance signal of 80 % amplitude. The signal is modulated with a 1 kHz sine wave, pausing to adjust the RF signal level or the switch coupling devices as necessary. Where the frequency is swept incrementally, the step size shall not exceed 1 % of the preceding frequency value.
- Attempts should be made to fully exercise the EUT during testing, and to fully interrogate all exercise modes selected for susceptibility.

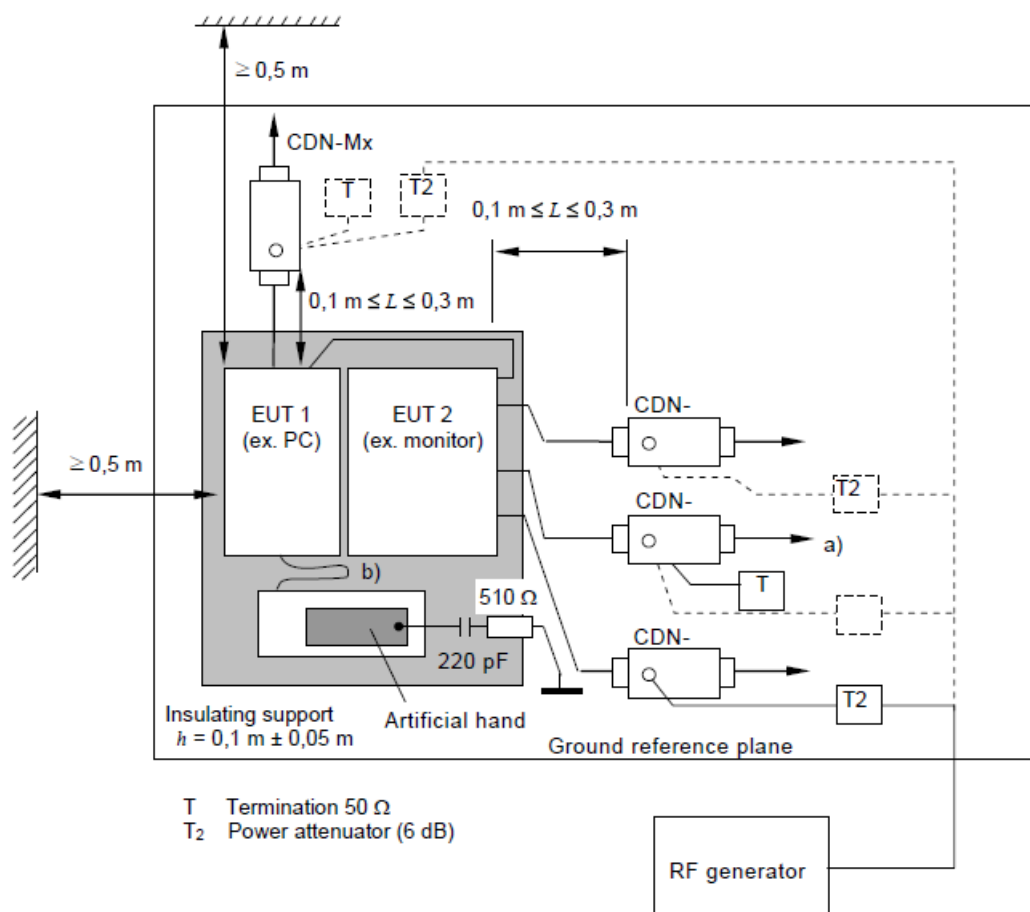

IEC 2606/13

- Note:**
- The EUT clearance from any metallic obstacles shall be at least 0,5 m.
  - Interconnecting cables ( $\leq 1$  m) belonging to the EUT shall remain on the insulating support.
  - The equipment to be tested is placed on an insulating support of 0.1 meters height above a ground reference plane. All relevant cables shall be provided with the appropriate coupling and decoupling devices at a distance between 0.1 meters and 0.3 meters from the projected geometry of the EUT on the ground reference plane.

For the actual test configuration, please refer to the related item – Photographs of the Test Configuration.

## 14.4 Test Results

### Mode 1

Input Power	230Vac, 50 Hz	Tested by	Chiming Li
Environmental Conditions	25°C, 66% RH		

Frequency (MHz)	Level (V rms)	Tested Line	Injection Method	Return Path	Observation	Remark	Performance Criterion
0.15 – 80	10	AC Power	CDN-M3	CDN-M1	Note 1	-	A
0.15 – 80	10	LAN (port 1)	CDN-ST08A	CDN-M1	Note 1	-	A
0.15 – 80	10	LAN (port 2)*	CDN-ST08A	CDN-M1	Note 1	-	A
0.15 – 80	10	LAN (port 2)**	CDN-ST08A	CDN-M1	Note 2	-	B

Note: The EUT is operated normal during the test.

\* As client's request, during the test the EUT LAN (port 2) test speed: 1Gbps

\*\* During the test the EUT LAN (port 2) test speed: 2.5Gbps.

## 15 Pictures of Test Arrangements

### 15.1 Conducted Disturbance at Auxiliary a.c. or d.c. power ports



## 15.2 Radiated Disturbance up to 1 GHz



### 15.3 Radiated Disturbance above 1 GHz

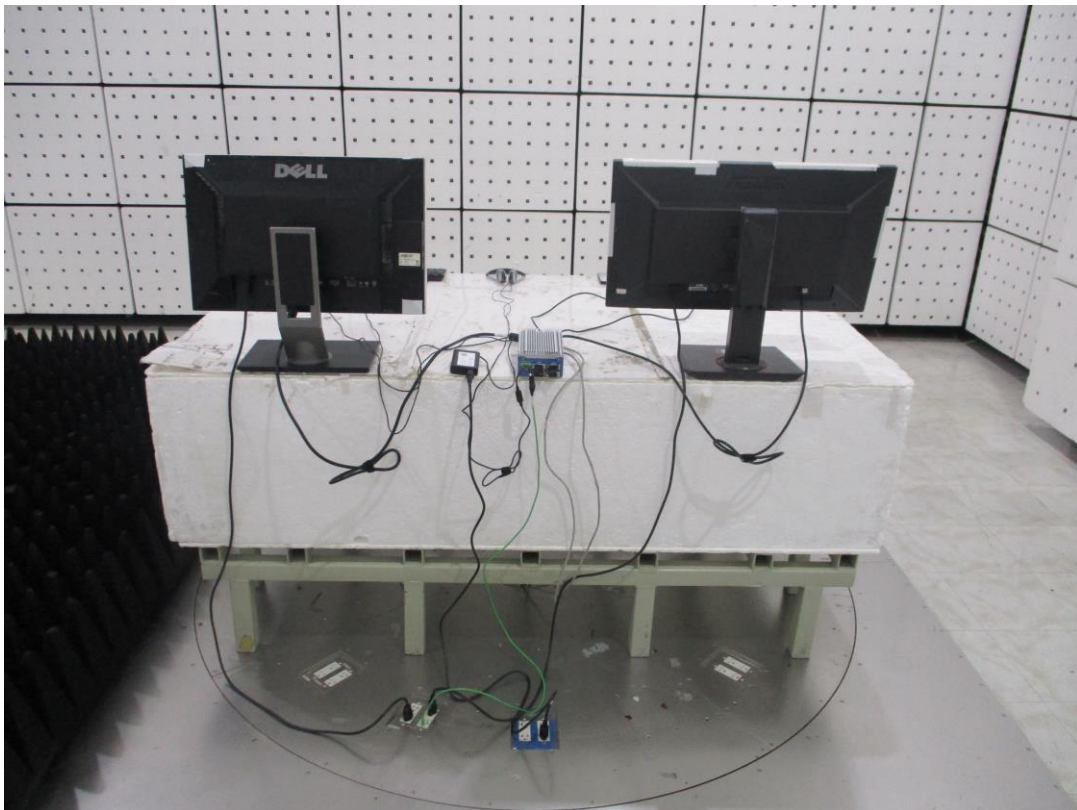

#### 15.4 Harmonics Current, Voltage Fluctuations and Flicker Measurement



#### 15.5 Electrostatic Discharge Immunity Test (ESD)



## 15.6 Radio-frequency Electromagnetic Field Immunity Test (RS)

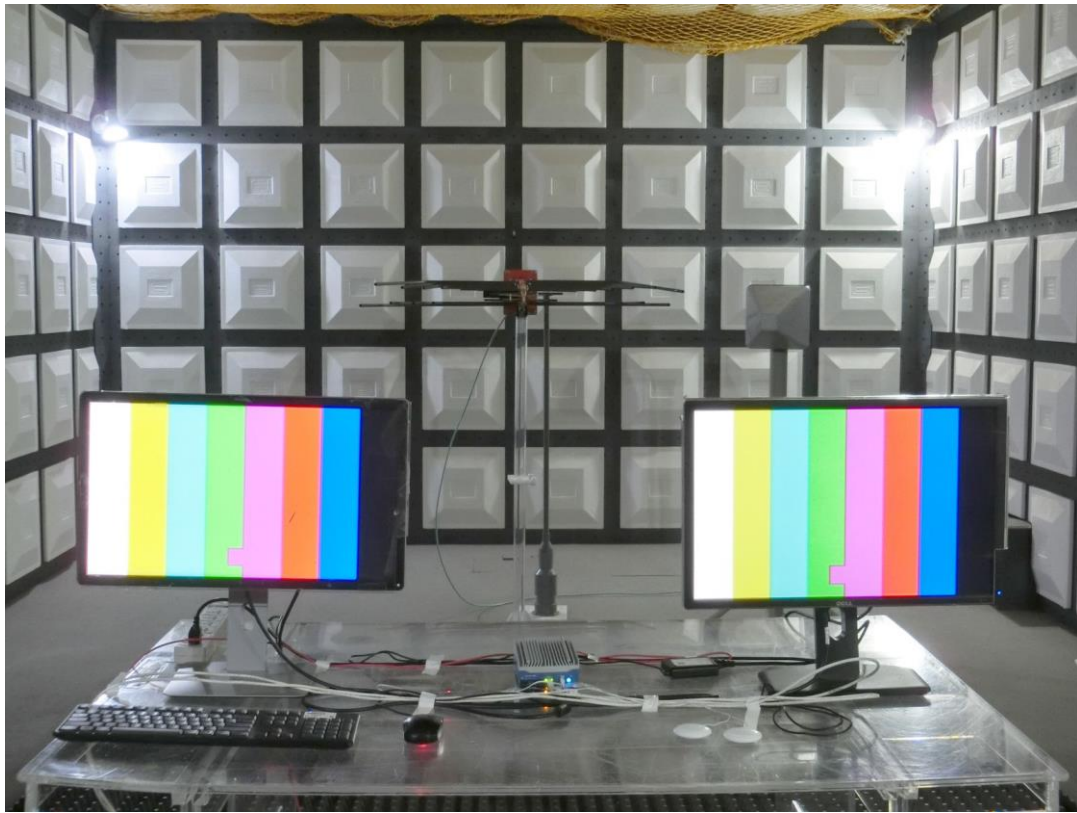

## 15.7 Fast Transients (EFT)

Mains port



LAN port 1

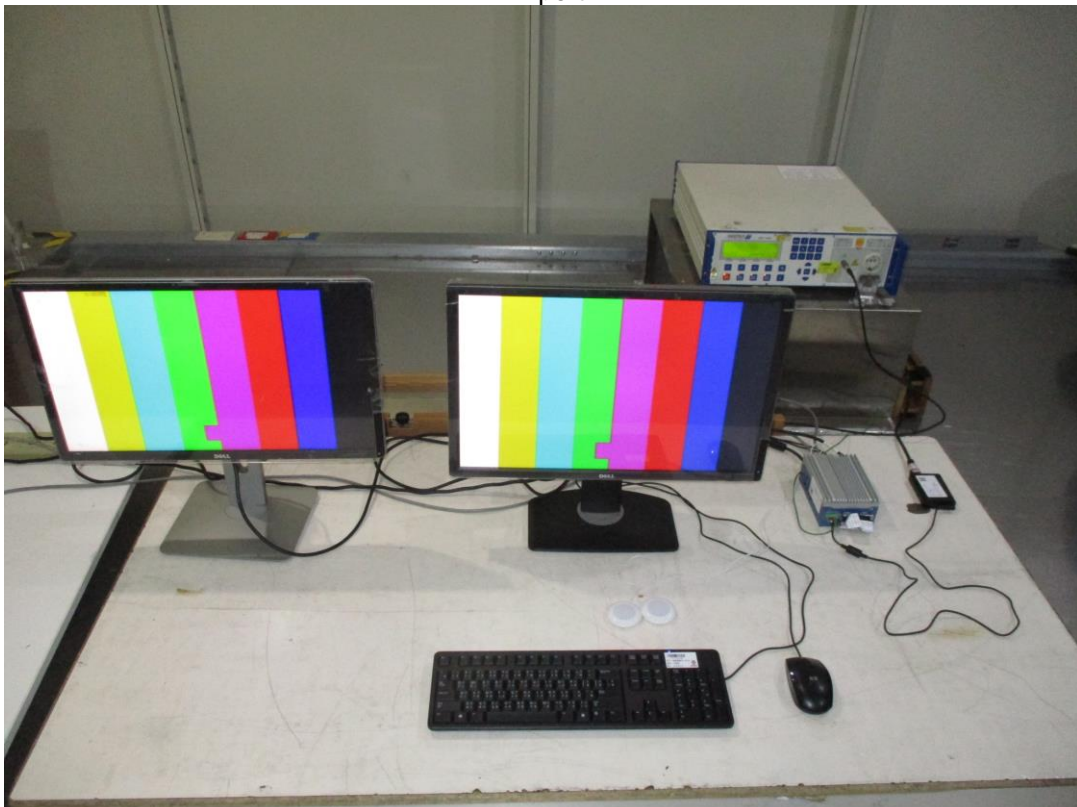



LAN port 2



## 15.8 Surge

### Mains ports



## 15.9 Radio-frequency common mode (CS)

Mains port

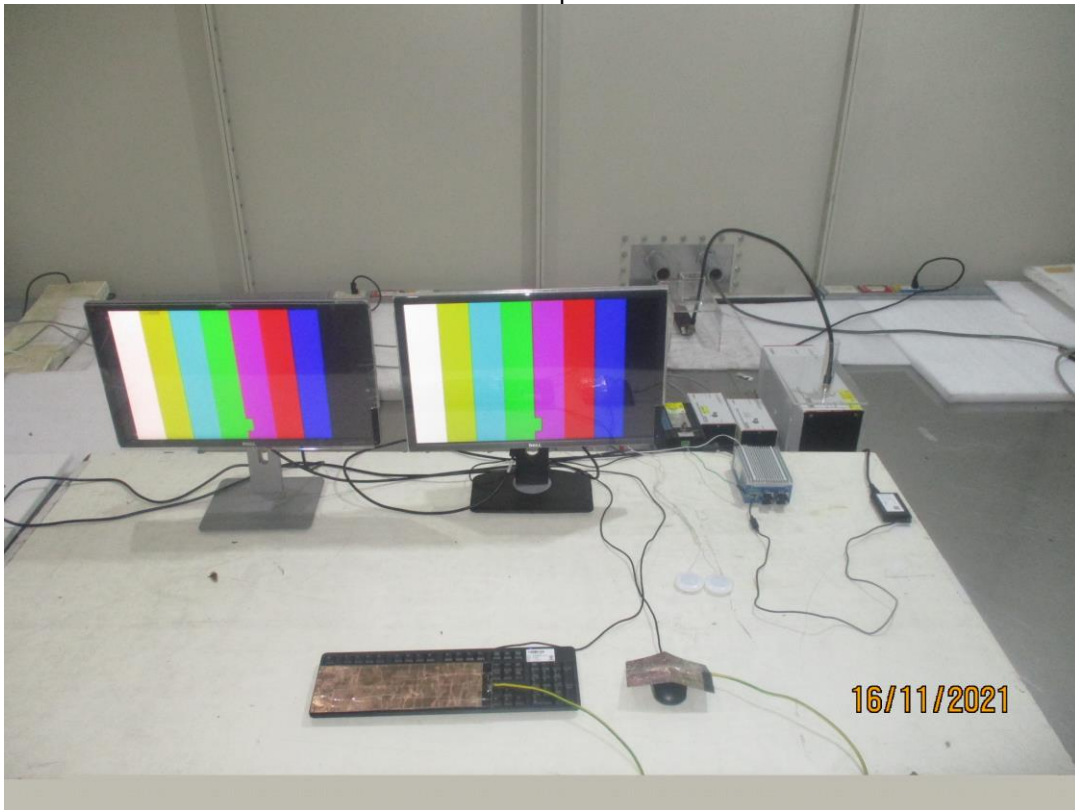

LAN port 1



LAN port 2

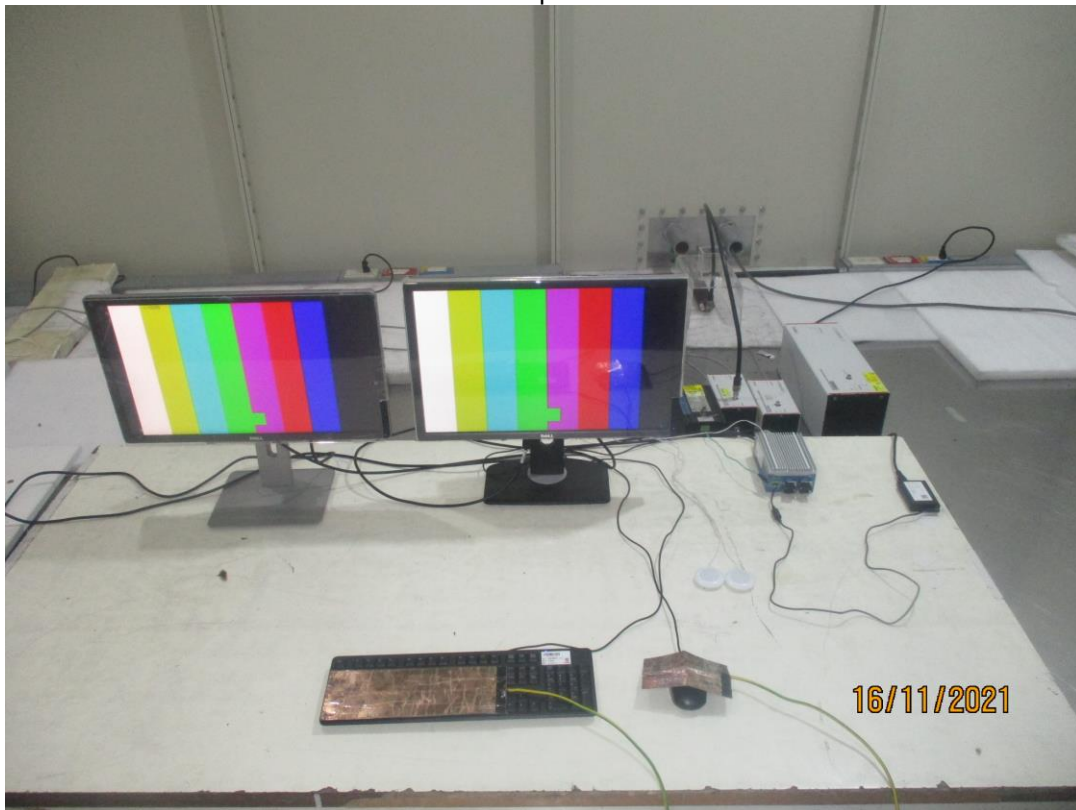

## Appendix – Information of the Testing Laboratories

We, Bureau Veritas Consumer Products Services (H.K.) Ltd., Taoyuan Branch, were founded in 1988 to provide our best service in EMC, Radio, Telecom and Safety consultation. Our laboratories are accredited and approved according to ISO/IEC 17025.

If you have any comments, please feel free to contact us at the following:

**Lin Kou EMC/RF Lab**

Tel: 886-2-26052180

Fax: 886-2-26051924

**Hsin Chu EMC/RF/Telecom Lab**

Tel: 886-3-6668565

Fax: 886-3-6668323

**Hwa Ya EMC/RF/Safety Lab**

Tel: 886-3-3183232

Fax: 886-3-3270892

**Email:** [service.adt@tw.bureauveritas.com](mailto:service.adt@tw.bureauveritas.com)

**Web Site:** [www.bureauveritas-adt.com](http://www.bureauveritas-adt.com)

The address and road map of all our labs can be found in our web site also.

--- END ---